

PROTEUS INSTRUMENTS

Proteus User Manual

V3.0 April 2024



Foreword

The material presented in this manual is designed to give the user a better understanding of the operation and maintenance of the Proteus multiprobe. Proteus Instruments advises all users to read the manual thoroughly before operating and deploying their probe.

Please note: this manual is for the current build state of Proteus. If you require a legacy version of the manual please visit www.proteus-instruments.com/manuals-and-data-sheets.

Any suggestions that would help improve the clarity of the information presented in this manual or additional information that would enhance understanding and operation is welcomed.

Proteus Instruments is committed to the improvement of its products and services therefore reserve the right to change instructions, specifications and schematics without notice.

Contact Information

Technical Support/Customer Service:

Tel: +44 1527 433221
Email: support@proteus-instruments.com (Technical Support)
info@proteus-instruments.com (Sales/General Enquiries)

Other Correspondence:

Address: Proteus Instruments Ltd,
Canalside, Harris Business Park,
Hanbury Road,
Stoke Prior, Bromsgrove,
B60 4DJ,
United Kingdom.

General Warnings:

Before operating or installing this equipment, it is important that all hazards are acknowledged and potential preventive measures are fully understood. In addition to site specific hazards related to location and application type, take heed of the following general warnings:



WARNING

Each fluorometer houses an ultra-violet LED. **DO NOT LOOK DIRECTLY AT THE LED WHEN THE PROTEUS IS CONNECTED TO POWER.** Exposure to UV light can cause damage to eyes. When looking at the optical window, use appropriate safety goggles.

This product should be kept away from children, pets and other animals.

DO NOT MANUALLY FORCE ROTATE THE WIPER ARM.

Pay attention and adhere to all local and international regulatory and legal requirements regarding the safe handling and disposal of calibration fluids, batteries and any other materials you use in connection with the Proteus.

Avoid hazardous practices when operating/installing this instrument. If used in any way not specified in this manual, protection provided by the instrument may be impaired.

Contents

CONTENTS.....	III
LIST OF FIGURES.....	IV
LIST OF TABLES.....	V
1. BACKGROUND.....	1
1.1 WHAT IS FLUORESCENCE?.....	2
1.2 MEASURING ORGANIC MATTER USING FLUORESCENCE.....	3
2. INSTRUMENT SPECIFICATIONS.....	4
2.1 INSTRUMENT.....	4
2.2 APPLICATIONS AND USER MODES.....	6
2.2.1 Real-time manual data collection.....	6
2.2.2 Unattended Logging.....	6
2.2.3 Telemetry.....	6
2.2.4 Online, Real-time Monitoring.....	6
2.3 STATUS INDICATOR LIGHTS.....	7
2.4 ACCESSORIES.....	8
2.4.1 Proteus High Range Dilution Sampling System.....	8
2.4.2 Remote Telemetry Systems	8
3. COMMUNICATION SOFTWARE.....	9
3.1 SYSTEM REQUIREMENTS.....	9
3.1.1 Proteus Manager and Serial Adaptors.....	9
3.1.2 Trouble Shooting.....	9
3.2 INTERFACE SCREEN.....	10
3.3 HOT BUTTONS.....	10
3.4 DROP DOWN MENUS.....	11
3.4.1 PC Menu.....	11
3.4.2 Proteus Menu.....	11
3.4.3 Proteus Control Interface	12
3.4.4 Custom Parameters.....	13
4. INSTALLATION.....	15
4.1 OPEN WATER INSTALLATION.....	16
4.2 FLOW CELL INSTALLATION.....	16
4.3 BD1 PORTABLE INSTALLATION EXAMPLES.....	17
4.3 BD3 PERMANENT INSTALLATION EXAMPLES.....	19
5. MAINTENANCE.....	24
5.1 ROUTINE MAINTENANCE AND CLEANING.....	24
5.2 TURBIDITY SENSOR AND WIPER ARM.....	23
5.3 FLUOROMETER MAINTENANCE.....	25
5.4 MAINTENANCE OF OTHER SENSORS.....	25
5.4.1 Reference Electrode.....	26
6. CALIBRATION.....	27
6.1 BASICS OF PARAMETER CALIBRATION.....	26
6.1.1 Calibration step-by step guide.....	28
6.1.2 Calibration Troubleshooting.....	29
6.2 CHOOSING CALIBRATION STANDARDS.....	29
6.2.1 Tryptophan Stock Solution.....	30
6.3 THE CALIBRATION LOG.....	32
6.4 SENSOR RESPONSE FACTOR (SRF).....	32
6.5 UNITS/CONVERSION FACTORS.....	32
6.6 FACTORY CALIBRATION FOR DERIVED PARAMETERS.....	32
6.7 TURBIDITY CALIBRATION.....	33
6.8 FLUOROMETER CALIBRATION.....	34
6.8.1 Typical Tryptophan Ranges and respective BOD.....	34

6.8.2 Temperature Compensation.....	35
6.8.3 Tryptophan Turbidity Compensation.....	36
6.8.4 Verification and Calibration.....	36
6.9 SITE-SPECIFIC CALIBRATION.....	37
6.10 PROTEUS SPIKE TESTING - SIMULATING A POLLUTION EVENT IN THE LAB.....	38
6.11 CALIBRATION OF OTHER SENSORS.....	43
6.11.1 Setting Time, Date and Barometric Pressure (BP).....	44
6.11.2 Dissolved Oxygen (ADO).....	45
6.11.3 Electrical Conductivity/Specific Conductance.....	46
6.11.4 pH.....	46
6.11.5 Oxidation-Reduction Potential (ORP)	46
6.11.6 Depth and Vented Depth (Gauge).....	47
6.11.7 Ion Selective Electrodes (ISEs).....	47
6.11.8 Total Dissolved Gas (TDG)	48
6.11.9 PAR.....	48
7. COMMUNICATION AND DATA LOGGING.....	49
7.1 INTERNAL DATA LOGGING.....	49
7.2 INTERNAL BATTERY PACKS.....	49
7.2.1 Battery Life.....	49
7.2.2 Changing the IBP batteries.....	50
7.3 BLUETOOTH.....	51
7.3.1 Connecting to Compatible Tablets and Smartphones.....	52
8. APPENDIX.....	53
8.1 ADDITIONAL TROUBLE SHOOTING.....	53
8.1.1 Communication with Computer.....	53
8.1.2 Measurement Values are Unrealistic.....	54
8.2 FREQUENTLY ASKED QUESTIONS.....	55
8.2.1 Sensors.....	55
8.2.2 Calibration and maintenance.....	56
8.2.2 Communication and software.....	57
8.2.4 Deployment and Actions.....	58
8.3 SIX WAYS TO POWER A PROTEUS.....	59
8.3.1 Using power from a Bluetooth Battery Pack (ordered separately).....	59
8.3.2 Internal Battery Pack.....	60
8.3.3 Using Power from a PC USB Port.....	60
8.3.4 Using power from the USB Adapter Power Connection.....	61
8.3.5 Using Power from your Own Battery or Other Power Source.....	62
8.3.6 Directly from a Proteus Telemetry Unit.....	63
9. GLOSSARY AND ABBREVIATIONS.....	64
CONTACT INFORMATION:.....	65

List of Figures

Figure 1: Example of quinine sulphate molecules in tonic water emitting blue light when exposed to high energy (UV) light.	2
Figure 2: Schematic representation of a simple fluorometer design.	2
Figure 3: An Excitation Emission Matrix (EEM) with key peaks highlighted.	3
Figure 4: Typical Proteus Equipment Overview; please note: this varies depending on individual requirements.	4
Figure 5: Optional Proteus Transport case.	4
Figure 6: Direct comparison of Proteus with IBP (foreground) and Proteus without IBP (Background).	5
Figure 7: An example of a Proteus set-up using solar power and transmitting data via to the outpost cloud server.	7
Figure 8: Flow Cell.	8
Figure 9: A Proteus connected to a PC using the supplied RS232 adapter and cable	9
Figure 10: Proteus control software interface screen.	10
Figure 11: Overview of Proteus Control software hot buttons. Please note, the numbers are for guidance only and do not appear on the actual interface.	10
Figure 12: Overview of PC menu on Proteus Control Software.	11
Figure 13: Overview of Proteus Menu on Proteus Control Software.	11
Figure 14: Sensor and Parameter list from Proteus Control Software.	12
Figure 15: PCI Connection command prompt.	12
Figure 16: PCI before connection to probe.	12
Figure 17: PCI with Proteus connected. 6. The 'Turb Port' should always show '3' – if it doesn't, disconnect the Proteus and restart the process from Step 1.	13
Figure 18: Successful coefficient upload message.	13
Figure 19: Custom parameter creation dialogue box.	14
Figure 20: Applying Molikote 111 to the connector plug	15
Figure 21: <i>The connector plug with Molikote 111 applied</i>	15
Figure 22: Installation of Proteus in open water with Sensor Guard and support structure.	16
Figure 23: Installation of Proteus in perforated stilling tube.	16
Figure 24: Proteus Flow cell with barbed connectors.	16
Figure 25: Example BD1 Natural Water Course Installation	17
Figure 26: Example BD1 Manhole/Chamber Installation	17
Figure 27: Example BD1 Tank Installation (solar panel not shown)	18
Figure 28: Example BD1 Open Channel Installation (solar panel not shown)	18
Figure 29: Left BD3 Frame Mounted Example Installation. Right BD3 Wall Mounted Installation	19
Figure 30: Example BD3 Water Course Installation	20
Figure 31: Example BD3 Open/Closed Tank Installation	21
Figure 32: Example BD3 Open Channel Installation	22
Figure 33: Example BD3 Chamber Mount Installation	23
Figure 34: (a) Location of set screw for removing the wiper (b) brush arm with wiper pad and brush highlighted (c) Diagram of the turbidity sensor, grub screw and Allen key.	25
Figure 35: Reference electrode and pH electrolyte solution (provided in maintenance kit).	26
Figure 36: Proteus Calibration Parameter List.	28
Figure 37: Proteus calibration window.	28
Figure 38: An example line from a Proteus calibration log showing a 0-turbidity calibration.	32
Figure 39: Sensor Response Factor Pop-Up.	32
Figure 40: Proteus Instruments default low range relationship (turbidity and temperature-corrected tryptophan).	33
Figure 41: Calibration set-up for fluorometer calibration.	34
Figure 42: Temperature-compensated TLF of a laboratory standard.	35
Figure 43: Change in fluorescence signal with turbidity.	36
Figure 44: Schematic of a site-specific calibration procedure.	37
Figure 45: A Proteus connected to a PC using the supplied RS232 adapter and cable	39

Figure 46: Example of simulated pollution event as a spike contaminant concentration (mL) in 4L volume after dilution.	40
Figure 47: Example of spike test set-up in the lab. A vertical clamp is recommended for ease of measurement.	41
Figure 48: Example of the format-example.csv spreadsheet. Yellow columns contain mean Proteus readings. Grey columns contain mean lab sample values.	42
Figure 49: Proteus Sensor Identification	43
Figure 50: Set Date and Time command prompt.	44
Figure 51: Set BP command prompt.	44
Figure 52: Changing of IBP batteries.	50
Figure 53: Proteus connected via BBP to a Bluetooth enabled tablet.	51

List of Tables

Table 1: Key for Figure 4	4
Table 2: Proteus Specifications	5
Table 3: LED Colour Guide	7
Table 4: Information on Calibration standards. NB: 'BP' stands for Barometric Pressure	30
Table 5: Guidance on average BOD ranges	35
Table 6: Spike test volumes. Values in bold indicate the contaminant volumes at each step.	40
Table 7: Approximate battery life of different Proteus sensor configurations	50

1. Background

The Proteus is a unique, patented and scientifically proven multi-parameter water quality probe. It can be fitted with up to 12 different sensors which can measure a multitude of different parameters simultaneously. Included in this list of sensors are an array of cutting-edge fluorometers that enable the previously unachievable real-time monitoring of:

- **Biochemical Oxygen Demand (BOD)**
BOD is a measure of the amount of oxygen that is used by bacteria and other microorganisms during the aerobic decomposition of organic matter.
- **Chemical Oxygen Demand (COD)**
COD is a measure of the amount of oxygen that is required to dissolve both organic and inorganic matter with the water.
- **Total Organic Carbon (TOC)**
A measure of the total amount of carbon present in organic compounds in a water source.
- **Dissolved Organic Carbon (DOC)**
A subset of TOC, dissolved organic carbon is the fraction of TOC which can pass through a 0.22 - 0.7µm pore size filter.
- **Total Coliforms, Faecal Coliforms and E. coli coliforms**
Coliforms are rod-shaped, gram negative bacteria. Total coliforms (TC) include all coliform bacteria that are present within the water source.

Faecal coliforms, a subset of TC, are a group that are classified by their presence in the gut and faeces of warm-blooded mammals. FC are considered a more specific indicator of faecal contamination than TC.

Escherichia coli (E. coli) coliforms (EC) are the major species in the FC subset. E. coli is the only species in the FC group that does not grow and reproduce in the natural environment and therefore can only come from faecal origin. As such, it is considered the best indicator of faecal pollution and by extension, the presence of pathogens.

For a comprehensive list of all the parameters that can be measured by the Proteus, please refer to the product datasheet.

1.1 What is Fluorescence?



Figure 1: Example of quinine sulphate molecules in tonic water emitting blue light when exposed to high energy (UV) light.

Fluorescence is a form of luminescence (i.e. the emission of light not attributed to thermal radiation) that occurs over very short time scales (10^{-9} – 10^{-7} s). The first fluorescent substance to be observed and recorded was quinine sulphate (a key ingredient in tonic water). In Figure 1 we can see fluorescence in action –the quinine sulphate molecules absorb ultra-violet light (short wave radiation) from the laser pen and then emit blue light (longer wavelength radiation). Molecules that exhibit this property are termed fluorophores. For fluorescence to be observed and quantified, a light emitter and detector is required with some optical components for isolating specific wavelengths of light. There are two types of fluorometers: (i) filter based, or (ii) monochromator diffraction grating (Figure 2), these differ in the way excitation and emission light is isolated from the wider spectrum.

Monochromator based fluorometers are generally restricted to the laboratory, while filter based units are used for field applications. Briefly, the light from the excitation source is directed through a series of lens and filters. When it reaches the sample, the light is absorbed and some of the molecules in the sample fluoresce. The fluorescent (emission) light passes through a second series of lens and filters/monochromator and reaches a detector (usually a photodiode). This photodiode is normally located at 90° to the incident light beam to reduce the potential for spurious readings due to stray excitation light reaching the detector.

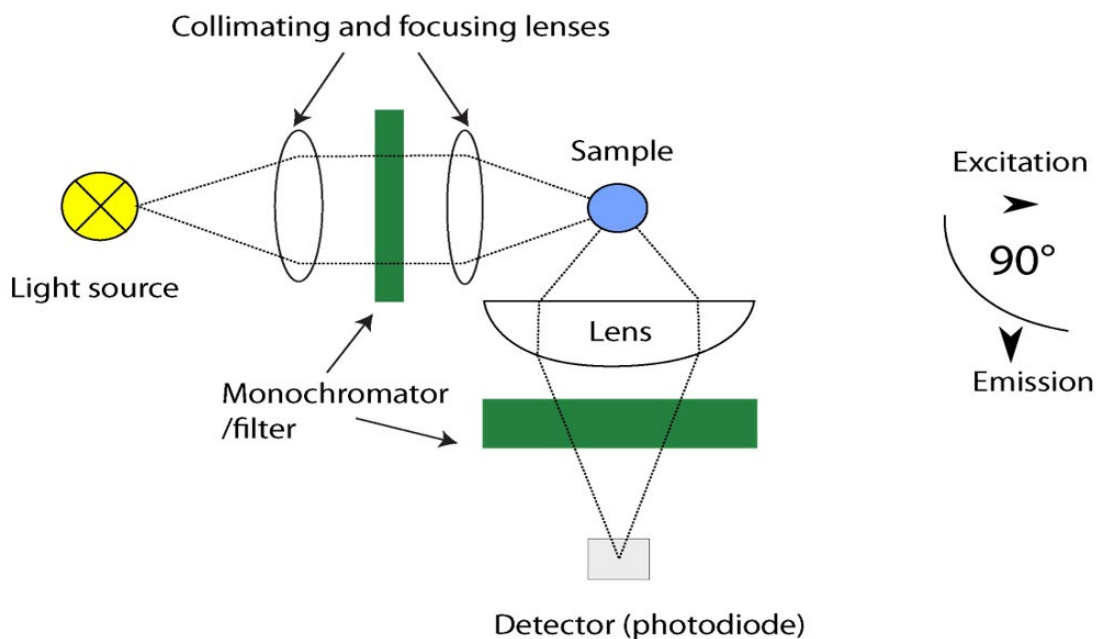

Figure 2: Schematic representation of a simple fluorometer design.

1.2 Measuring Organic matter using Fluorescence

A significant proportion of Chromophoric (light absorbing/coloured) organic matter is fluorescent when excited by light in the UV region. Using laboratory fluorometers that scan the full spectrum of excitation and emission wavelengths (Excitation Emission Matrix spectroscopy; EEM), distinct fluorescent peaks have been identified (Fig. 3). These are related to certain 'types' of organic matter, for example, humic-like fluorescence (Peaks A and C on Fig. 3) can be traced back to terrestrial production by vascular plants, while protein - like fluorescence (Peaks T and B; Figure 3) is largely related to in-stream production by algae and bacteria. Strong relationships between conventional water quality parameters and fluorescence peaks have been identified of particular interest are the correlations between: (i) dissolved organic carbon and humic-like fluorescence (A and C) and (ii) biochemical oxygen demand (BOD) and tryptophan-like fluorescence (Peak T).

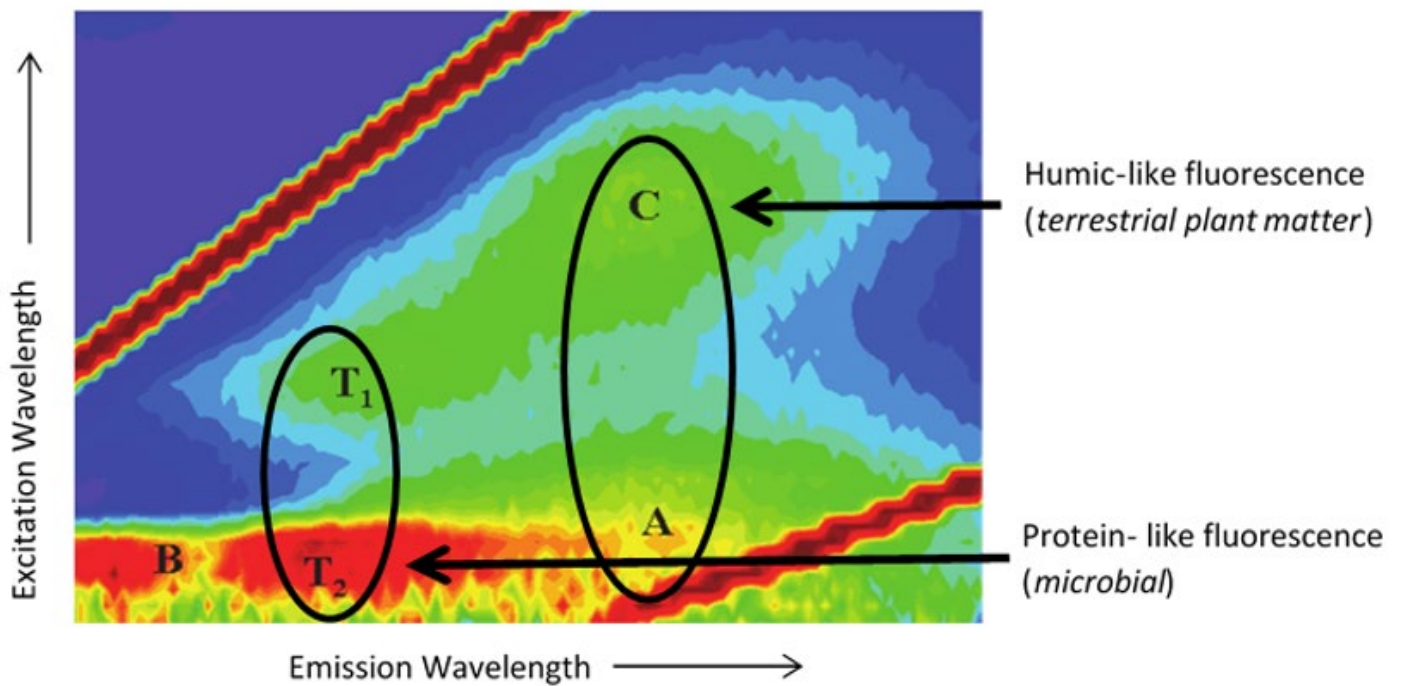

Figure 3: An Excitation Emission Matrix (EEM) with key peaks highlighted.

2. Instrument Specifications

2.1 Instrument



Figure 4: Typical Proteus Equipment Overview; please note: this varies depending on individual requirements.

Table 1: Key for Figure 4

1. Sensor Guard	6. Proteus Manager
2. Sensor Array	7. Comms Cable
3. Proteus Body/Housing	8. Serial USB Adaptor
4. Marine cable with Comms Connector	9. Internal Battery Pack
5. Calibration Cup	



Figure 5: Optional Proteus Transport case

Table 2: Proteus Specifications

Dimensions	OD 114.0mm*, L530 mm*
Weight	4-7kg
Temperature operating range	-5° C to +50° C (non-freezing)
Depth Rating	200m (except ISE sensors = 10m, TDG/Low Range Depth = 25m*)
Supply Voltage	5-15vdc
Signal Outputs	Native RS232 or optional internal integrated Modbus 485/SDI-12. Optional external convertor for RS232 to SDI12. (SDI12/RS485/Modbus optional)
Communications	RS232, Modbus 485, SDI-12 & Optional Bluetooth Module
Sample Rate	≥1Hz
Internal Memory	4MB; >1,000,000 readings
Warranty	24 months (options to extend)

*depending on specification purchased

If you require individual sensor specifications, please contact us directly.



Figure 6: Direct comparison of Proteus with IBP (foreground) and Proteus without IBP (Background).

2.2 Applications and User Modes

2.2.1 Real-time manual data collection

Manual Data collection, also referred to as profiling, surveying, spot measurements etc., means the user is present at the monitoring site and uses a data display for observing measurements. This allows the user to make informed, data-based decisions in real-time in the field. The data display for the Proteus can be read through a variety of mediums such as on a compatible laptop via a data cable/marine cable. Real-time data to a laptop will be displayed on the Proteus Manager and can be 'snapshotted' at user defined intervals to a csv file. The Proteus data can also be accessed using a compatible Bluetooth enabled tablet and/or smartphone; this requires an additional purchase of the Bluetooth battery module.

2.2.2 Unattended Logging

Unattended logging enables the Proteus to be deployed and then left unattended for the required amount of time to collect the desired data. The Proteus has an optional Internal Battery Pack (IBP) that can be used for unattended logging. The IBP can power the Proteus for a number of weeks/months depending on sensors and logging frequency. Alternatively, the Proteus can be connected to an external battery or other DC power supply and be powered indefinitely. The Proteus can store over 1,000,000 readings which can be downloaded at your convenience to a compatible PC/laptop or Bluetooth enabled device.

2.2.3 Telemetry

The Proteus can be connected to a variety of telemetry devices while it is deployed. The Proteus is designed as telemetry agnostic, allowing it to use a variety of communication protocols to interface with different telemetry systems.

These protocols include:

- RS232 (native)
- Modbus 485 (optional integrated)
- SDI12 (optional integrated or external)

The optional Proteus supplied telemetry system uses a cloud server and mobile phone network to transmit and store data with extensive options to integrate datasets via API/REST/FTP/Email connectivity.

Most telemetry systems can both display data and communicate with the Proteus to enable actions such as a trigger a wipe cycle. Telemetry can be used to view data in near real-time as well as track long-term trends while identifying optimal times for probe maintenance.

2.2.4 Online, Real-time Monitoring

Online monitoring allows the Proteus to report data in real-time while being integrated into an existing online network such as PLC or SCADA-based systems. Often referred to as process control monitoring, the data from the Proteus will enable the user or system to make water-quality-based decisions in real-time.

The Proteus can connect using SDI-12, RS232 or Modbus 485; please specify your preference at the time of purchase. Below is an example of a portable telemetry system within a Pelicase (with/without solar panel) that can be deployed quickly in the field.



Figure 7: An example of a Proteus set-up using solar power and transmitting data via to the outpost cloud server.

2.3 Status Indicator Lights

The Proteus and the external SDI-12 adaptor (see section 6.5) have three light-emitting diodes (LEDs) mounted on the circuit board top. They are visible from the outside through the transparent housing of the SDI 12 converter and on the top of the sensor housing in the stainless model. These LED lights indicate the instrument's operating status and can be used to troubleshoot problems.

Table 3: LED Colour Guide

LED COLOUR	PROTEUS	EXTERNAL SDI-12 CONVERTER
Green	Blinks every second when unit is receiving adequate operating voltage.	Pulses when the converters CPU is ready.
Yellow	Blinks when the sensor is receiving RS232 communications.	Used for factory diagnostics.
Red/Blue	Red light blinks during power up.	Blue light remains on when powered up.

2.4 Accessories

The Proteus can be supplied with a flow cell that is sized depending on your application requirements. Flow cells can be used where it isn't possible to deploy the Proteus directly into the water source. They also can be designed as a dilution solution, when specific parameters exceed thresholds.

We recommend using a dilution system in instances where Turbidity regularly **exceeds 400 NTU** as the optical sensors cannot achieve a clear reading.

Flow cells can be used either under the influence of gravity or have water pumped in using a peristaltic pump. If pumping is required, sample lines should be limited to 15psi/1 bar/10m H₂O, in order to protect the flow cell and sensors from damage. The external diameter of the barb connector thread is 10mm.

If you have any questions about a potential set-up, please get in touch with us.



Figure 8: Flow Cell

2.4.1 Proteus High Range Dilution Sampling System

Dilution systems are recommended for environments where BOD/COD is likely to be consistently in excess of 350/700 mg l⁻¹ respectively. We can provide a high range dilution sampling system which uses a peristaltic pump to move water samples to and from the flow cell. The system is supplied with a kiosk and wall mounting plate for easy installation. Ratio rates can be controlled by sizing peristaltic pumps and their flow rates for ratios up to 1:40. This means that potential monitoring ranges can be up to 14000/28000mg l but do require a drinking water supply. The sampling system can be pulsed or continuous. In continuous mode, a new sample is being continually provided to the flow cell whereas a pulsed sample may be a 1-minute sample every 15 minutes. The later has the advantage of saving power in low power applications and also wear & tear on moving parts.

Our flow cells are cut to size depending on your requirements; please get in touch with us for more details.

2.4.2 Remote Telemetry Systems

For remote applications, Proteus Instruments has designed a range of telemetry options to suit a variety of equipment set-ups. The telemetry relay can be housed in a custom-built Pelicase (Figure 7) or outstation. Both options are identical and include a GPRS telemetry unit (SDI-12) with relay switch, internal fuse terminal block, 12V 6A charge regulator and a 20W rigid solar panel; the only difference is the physical housing.

We also provide an outstation option with a mains AC input (including the AC/DC transformer for sensors) if solar power is inappropriate for the application.

3. Communication Software

3.1 System Requirements

The Proteus Manager runs on MS Windows and does not require a large amount of space or RAM for it to function fully.

Ensure the software is fully installed before connecting your Proteus for the first time.

3.1.1 Proteus Manager and Serial Adaptors

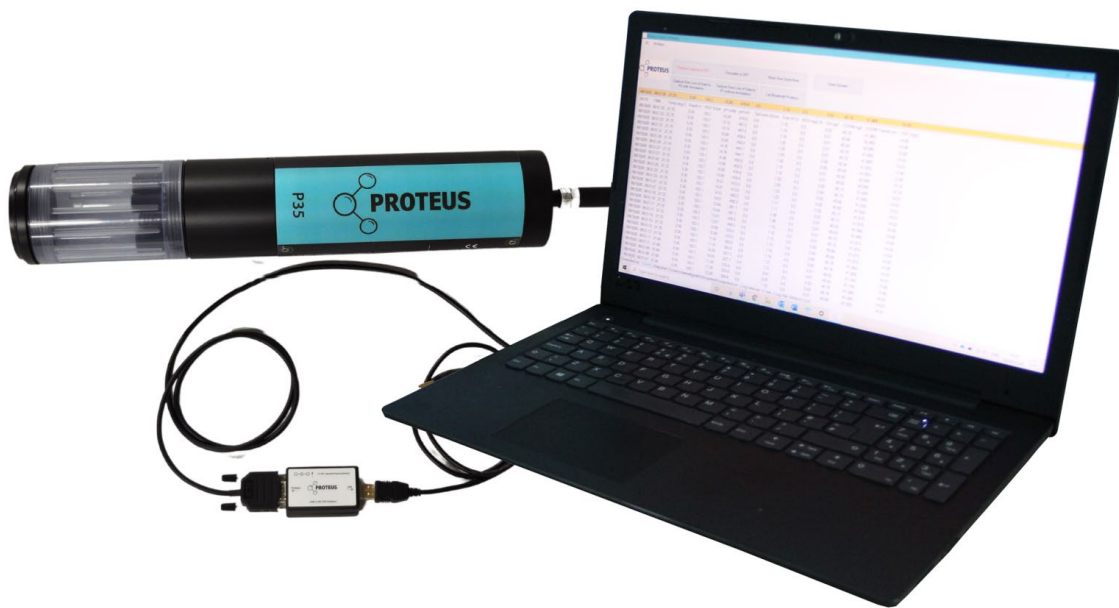

Figure 9: A Proteus connected to a PC using the supplied RS232 adaptor and cable

Within the box there will be a memory stick containing the program for install. If you have misplaced the memory stick, please get in touch with us for a software link.

The Proteus connects and communicates with your PC using a USB Serial adaptor. Installation of the USB driver should be automatic following plug-in and acceptance of install.

Once the Proteus is plugged in via the adaptor to your PC, start the Proteus Manager. If you have a highly specified Proteus or with a long cable length (>30m) you may need the auxiliary power supply that connects into the USB adaptor. (See 'Connecting a Proteus via an RS232 adaptor on the accompanying USB stick.)

The Proteus Manager will scan all available ports for the Proteus every 30 seconds. Once it has been detected the program will identify the port on the bottom left bar and within a few seconds the data will start scrolling (Figure 10).

3.1.2 Trouble Shooting

If the Proteus isn't detected by the software, check all cable connections or use a different USB port. If the issue persists, close the software and disconnect the Proteus and wait 20 seconds before re-attempting. Ensure all USB drivers on your machine are up to date; this may require administration privileges from your IT supervisor.

3.2 Interface Screen

When the Proteus is plugged into a computer via the USB connector and the Proteus Manager is started the interface screen below (Fig. 10) will appear. Initially the software will search for the Proteus on available COM ports, after about 20 -30 secs the connection will be completed and readings will start to scroll down the page.

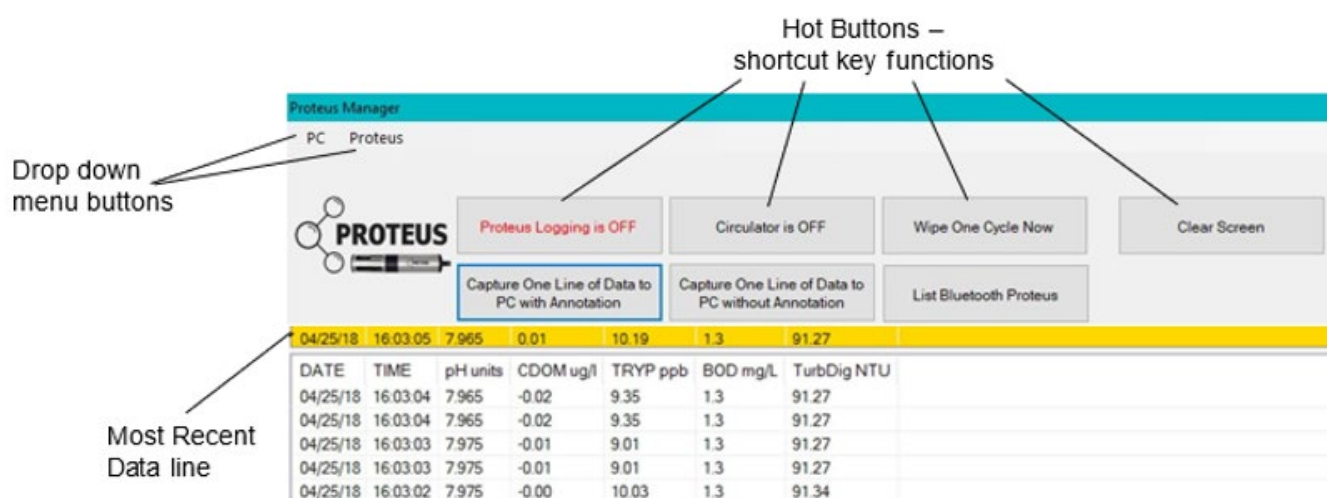

Figure 10: Proteus Manager interface screen.

3.3 Hot Buttons

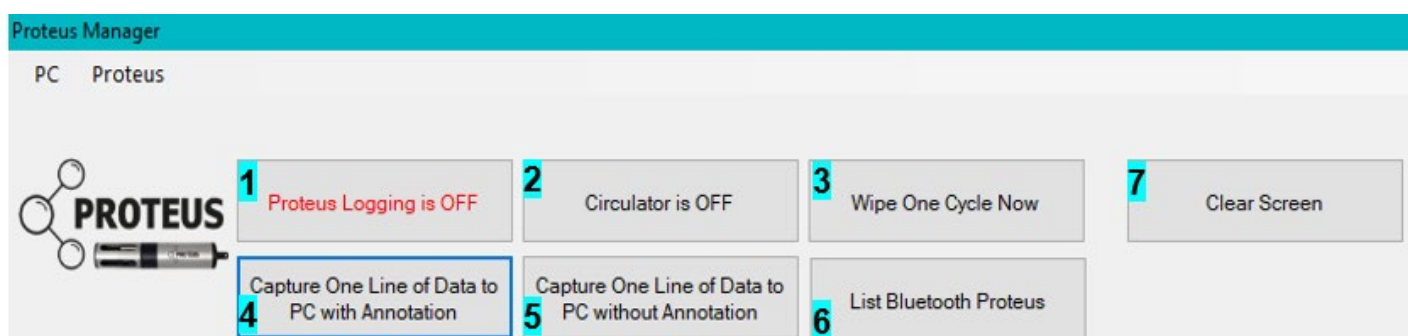

Figure 11: Overview of Proteus Manager hot buttons. Please note, the numbers are for guidance only and do not appear on the actual interface.

1. Informs the Proteus that logging mode is enabled/disabled. To activate unattended logging, the switch plate on the Proteus must also be moved into the 'on' position (Figure 50).
2. Switches the circulator on/off. The circulator is seldom used unless you have specifically requested an electrode DO sensor, the Proteus is almost always equipped with an optical DO sensor (HDO), as optical sensors are far more accurate and efficient.
3. Triggers a wipe cycle of the turbidity sensor.
4. Used to save the most recent line of data (displayed in the yellow band) to your snapshot file location with any annotation.
5. Used to save the most recent line of data (displayed in the yellow band) to your snapshot file location without any annotation.
6. (Legacy feature) Scans for and lists any Bluetooth enabled Proteus probes – not compatible with the current BBP version).
7. Clears all data from the screen but does not disable scrolling; the screen will re-populate with data until the Proteus is disconnected.

3.4 Drop Down Menus

The Proteus Manager has two Drop-Down Menus; 'PC' and 'Proteus'. Within these two menus all the software settings and calibration tools can be accessed.

3.4.1 PC Menu

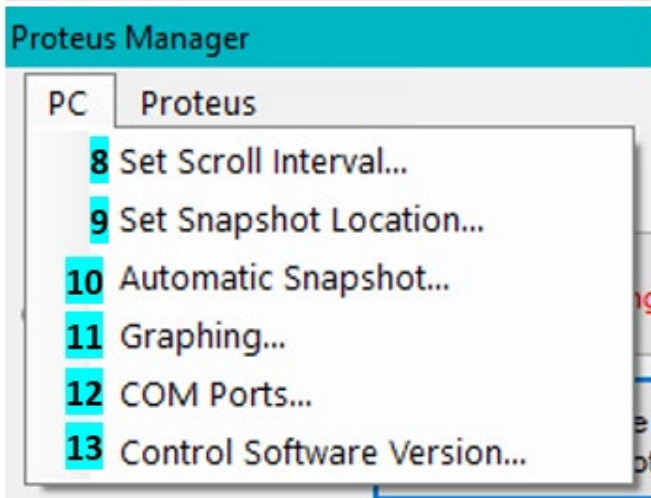

Figure 12: Overview of PC menu on Proteus Manager.

8. Used to change the time interval for the lines of data displayed on the software screen
9. The 'Snapshot' refers to the storing of a single line of data and 'location' refers to where on your device the 'snapshot' is stored. The Snapshot Location is displayed at the bottom of the screen for your convenience.
10. This option enables the Proteus to log and store the data in your chosen location automatically. Data is logged at the same interval as your scroll interval.
11. Displays the data in a graphical format.
12. The Proteus will automatically scan COM ports for connected Proteus probes but this option allows COM ports to be selected manually. This is more applicable if you have multiple units connected.
13. Displays the control software version.

3.4.2 Proteus Menu

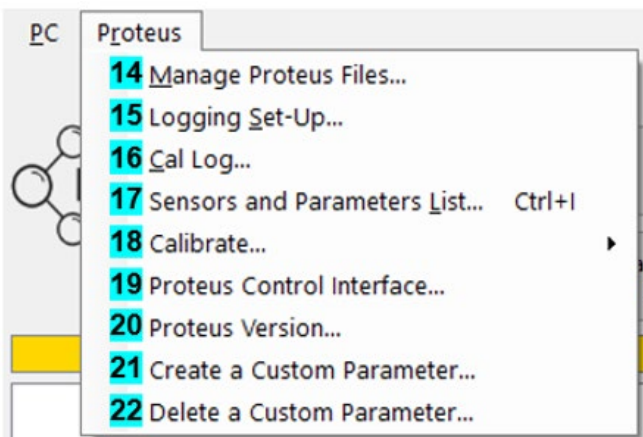

Figure 13: Overview of Proteus Menu on Proteus Manager.

14. Enables access to files stored on the Proteus allowing viewing, deletion and saving to PC.
15. Changes the logging settings and existing log files. The active log file name is displayed on the bottom line of the main screen.
16. Displays the calibration log.
17. Displays the sensor and parameter list (Figure 14). Parameters with a tick next to them are displayed on the main interface in the order shown on the list.
18. Opens separate menu of parameters for calibration. This list includes every possible parameter a Proteus can have, but you can only calibrate for parameters where you have the corresponding sensor. For more information on calibration procedure, see Section 6.
19. Opens the Proteus Control Interface – only compatible with Proteus units manufactured after September 2020. For instructions see Section 3.4.3.
20. Displays the firmware version the Proteus is using.
21. Opens a dialogue box for the creation of a custom parameter (See Section 3.4.3).
22. Enables the deletion of a custom parameter.

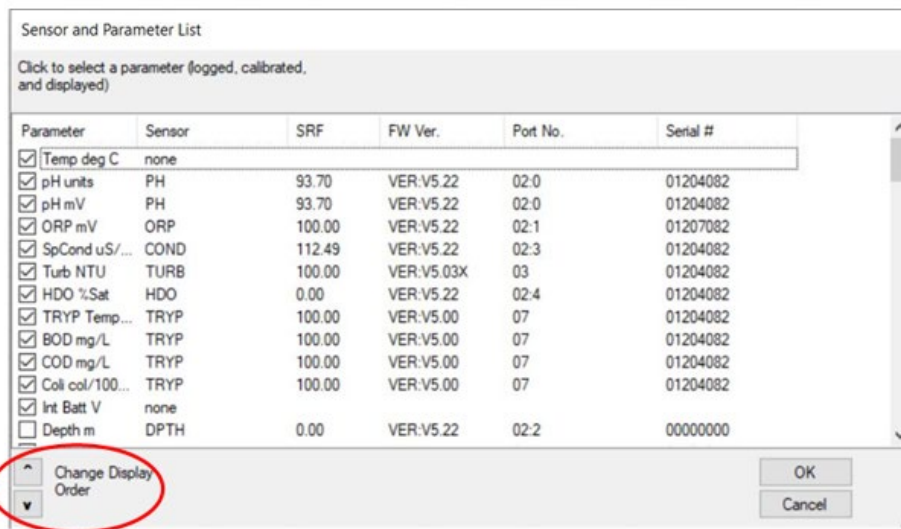

Figure 14: Sensor and Parameter list from Proteus Manager.

WARNING: This order is also maintained in any logging files and snapshot files, as well as being the setting on the native RS232 and SDI-12 outputs. If you reorder the parameters but do not re-program the communication protocols, they will be improperly indexed and the output data will be mis-matched with the parameters. This also affects telemetry systems.

For more information, please refer to the separate RS232 manual which is available on request.

3.4.3 Proteus Control Software

The Proteus Control Interface (PCI) is software that enables the user to download the algorithm coefficients directly to their Proteus multiprobe. Each Proteus is sent with the relevant stock coefficients, the PCI can be used to change these to different environments or to load site-specific coefficients based on client sampling. Once you have submitted data for analysis to our engineers, you will be emailed once your coefficients are on the server and available for download via the PCI.

PLEASE NOTE, THIS SOFTWARE IS ONLY COMPATIBLE WITH PROTEUS UNITS MANUFACTURED AFTER SEPTEMBER 2020. IF YOU HAVE A UNIT MANUFACTURED BEFORE SEPTEMBER 2020, COEFFICIENTS STILL HAVE TO BE CHANGED MANUALLY BY OUR ENGINEERS.

To use the PCI software:

1. Connect your Proteus to your laptop/PC as normal using the comms cables and launch the Proteus Manager. Your laptop/PC must have an internet connection.
2. On the Proteus Manager, open the Proteus Menu (Figure 13) and select 'Proteus Control Interface'.
3. The Proteus Manager window will shut and a prompt (Figure 15) will show, click 'ok'.
4. Figure 16 will display; the Proteus Port will automatically detect which COM port the Proteus is plugged into – click 'connect' to make the connection.
5. Enter the licence key into the 'key' field manually. This will have been emailed to you by a technician. If you cannot find your key, email support@proteus-instruments.com.

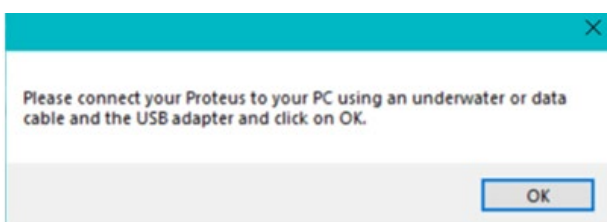

Figure 15: PCI Connection command prompt.

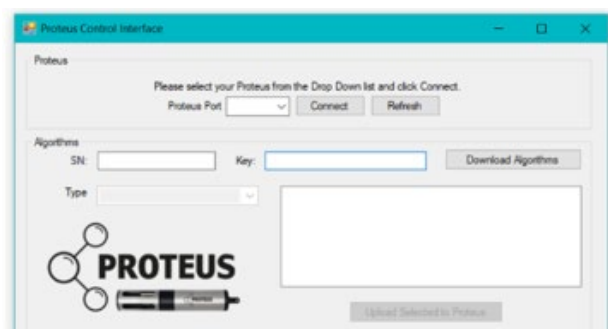
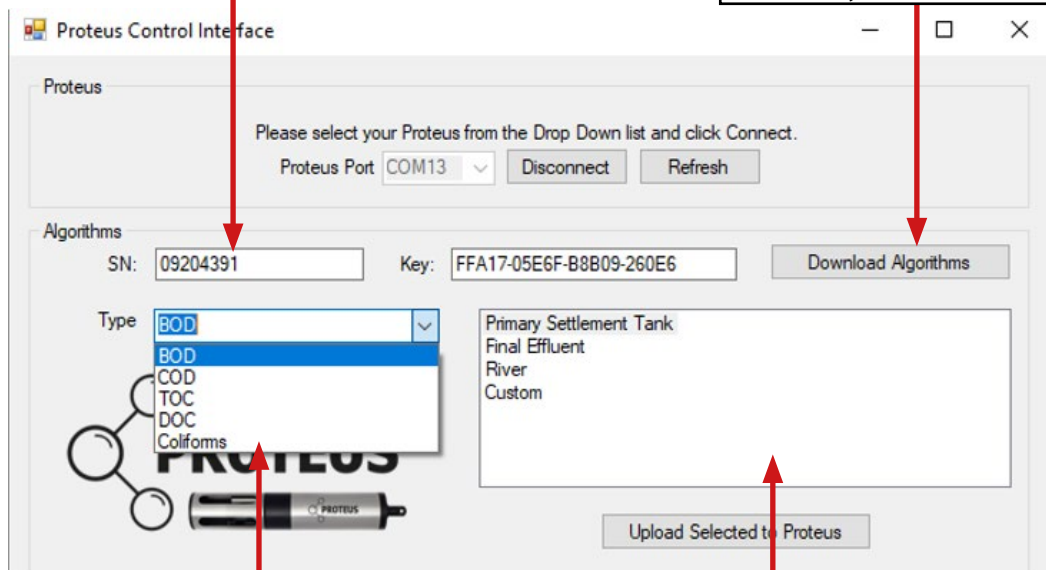

Figure 16: PCI before connection to probe.

6. A successful connection will produce the following (Figure 17).

A. The serial number of the unit will show here.
If it doesn't appear automatically, you can type it in manually.

B. Click this button to download all available parameter coefficients; ensure licence key is entered first.



C. Use this dropdown menu to select the parameter to upload.
Please note the parameters shown here are only the ones purchased with that Proteus.

D. This box shows all the variations of the selected parameter. If you are uploading your site calibration, select 'custom'.

Figure 17: PCI with Proteus connected.

7. Once you have used 'C' and 'D' to select the desired parameter, click the 'Upload Selected to Proteus' button.
8. Once successful, a message will show to confirm.
9. Close the software and unplug the Proteus to write the uploaded algorithm to memory.

The parameters can be overwritten at any time, as many times as required. If you are unsure which parameter algorithm coefficients you have loaded, simply overwrite them with the desired selection.

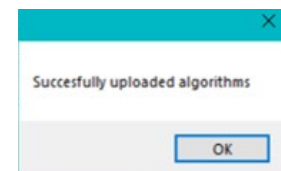

Figure 18: Successful coefficient upload message.

3.4.4 Custom Parameters

Custom parameters, such as TSS, are normally requested at time of purchase and programmed by Proteus technicians. However, they are relatively straightforward for the user to self-programme.

To create a Custom Parameter:

1. Following option selection, a dialogue box (Fig 19) will open which needs to be filled.
2. For 'name' include both the parameter name and the units it will be reporting in e.g. TSS (mg/L)
3. For the equation, ensure you enclose the whole expression in parentheses () and use your keyboard keypad, if you have one.
4. If a 'parameter creation successful' message is shown:
 - a) Close the software
 - b) Disconnect the USB cable from the laptop
 - c) Wait 10 seconds
 - d) Reconnect USB cable to Laptop (commits commands to CPU)
 - e) Start the software
 - f) Open the Sensor and parameter list in the drop-down menu and check TSS mg/L is listed. When selected this should then be added to the scroll interface.

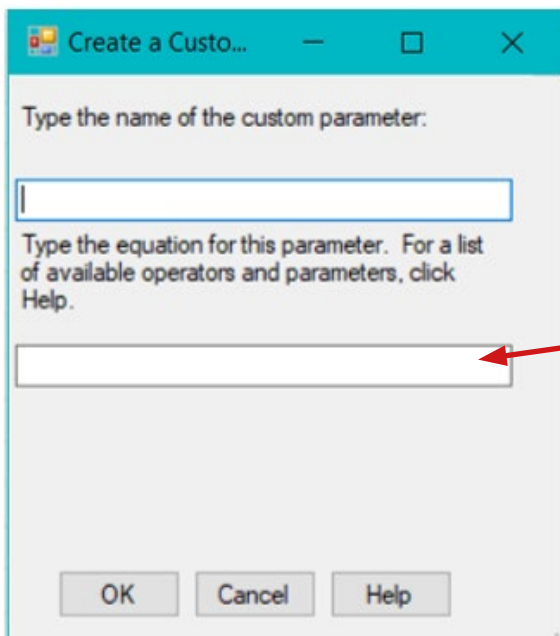

Unique multiplication factor (Based off of site sampling and data analysis).

Using TSS as an example, the equation would appear as follows:
 $((TURB_NTU)*2.0135)$

Parameter already in existence as it appears on the Proteus scrolling interface and parameter list. [spaces] should be filled with an underscore [_].

Figure 19: Custom parameter creation dialogue box.

Trouble shooting:

- Occasionally the message returned may read 'parameter not created'.- Ensure Proteus is connected and software open
 - Press <CTRL>+<ALT>+<E> simultaneously to load the Command Prompt dialog.
 - In the "To Send" edit box, enter the command p -l Typed as p[space]-l
Note: Be sure to include the negative symbol (-) and l = The letter l as in Indigo, not numerical 1.
 - Press <ENTER> on your keyboard ("Send" function in the software does not always work).
 - The parameter list should be displayed, scrolling to the bottom, the last parameter should be shown as "TSS ((TURB_NTU)*2.0135)". If not, Click "X" to close this dialog and try creating the parameter again.
- Parameter creation can be unsuccessful for the following reasons:
 - Spaces have been used in the formula.
 - Forbidden characters have been used in the formula (full list on help tab).
 - More than 6 characters have been used in the name of the custom parameter.
 - Too many decimal places have been used (maximum should be two decimal places).

- If a successful creation message is shown but the parameter does not appear in the list, cycle the power by closing the software and disconnecting the Proteus, then waiting 10 seconds before reconnection.
- If it shows in the parameter list but cannot be added to the interface then delete the parameter and create the parameter from scratch.
- If the parameter fails to be deleted, cycle the power by closing the software and disconnecting the Proteus, then waiting 10 seconds before reconnection.

4. Installation

Due to the versatility of the Proteus, it is possible to use the Proteus for a range of applications spanning a variety of water environments (natural – engineered). In this section, installation recommendations are outlined for the two most commonly encountered applications. The Proteus has internal logging capabilities or can be connected to an external data logger (Section 6). If internal logging is required, ensure logging has been activated via the Proteus Manager interface (Section 3), then connect the external battery pack to the Proteus; for internal battery packs, flip the ON/OFF switch plate to ON. Logging will continue until power (external battery pack) is removed/ depleted or the switch plate is set to OFF.

Please Note: When using the Marine Cable to connect to Proteus to be deployed, smear the flat face of the connector plug with Molikote 111 to ensure a watertight connection.



Figure 20: Applying Molikote 111 to the connector plug



Figure 21: The connector plug with Molikote 111 applied

4.1 Open Water Installations

A vertical clearance of 75mm (provided by the Sensor Guard) is required for optical sensors (fluorometers, turbidity and DO) as backscatter can cause spurious data. The sensor should always be installed with the Sensor Guard securely fastened and, whenever possible, with the multiprobe in the vertical position (Figure 22). In larger streams and rivers where highly variable flows are anticipated, the multiprobe should be adequately protected from floating debris. We advise installing the sensor in a perforated stilling tube (Figure 23), to both protect the sensor and reduce ambient light interference. To secure the multiprobe use large cable ties attached to at least two points on the multiprobe (avoid using clamps as this can damage the instrument). Avoid installation in locations where deposition of sand/silt is likely or near sources of aeration as bubbles and turbulence will interfere with sensor readings.

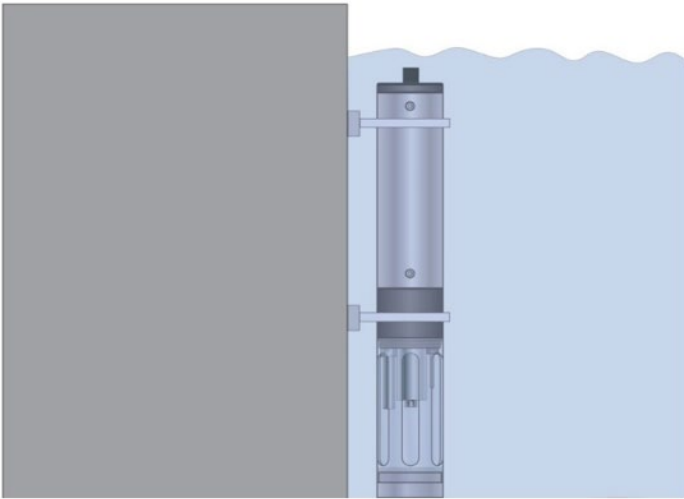

Figure 22: Installation of Proteus in open water with Sensor Guard and support structure.

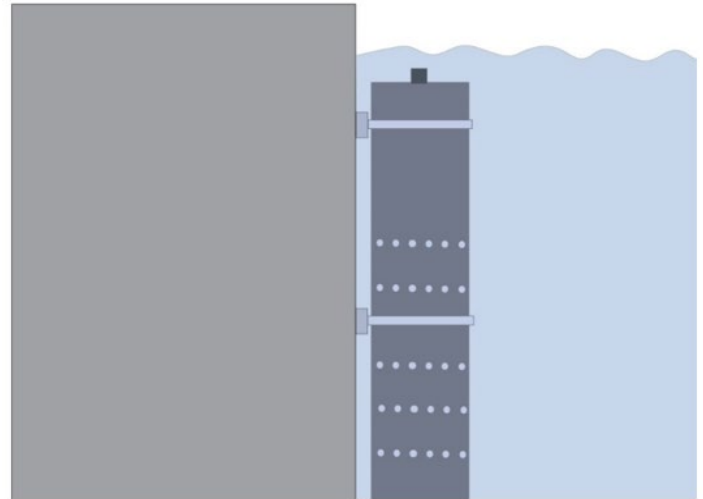

Figure 23: Installation of Proteus in perforated stilling tube.

4.2 Flow Cell Installation

An alternative installation option involves non submersible deployment, usually associated with a peristaltic pump through or process applications. If this is desirable attach the flow-cell (Figure 24) to the Proteus in place of the sensor guard and attach the feed line to the barbed connectors.

Ensure all connections and hoses including barbed connectors (Figure 24) have the correct pressure rating and **does not exceed 15 psi/1 bar/10mH₂O**. It is recommended that any debris is filtered from the feed line using a mesh screen in line; 250 - 500 μ m is normally sufficient for this purpose.



Figure 24: Proteus Flow cell with barbed connectors.

4.3 BD1 Portable Installation Examples

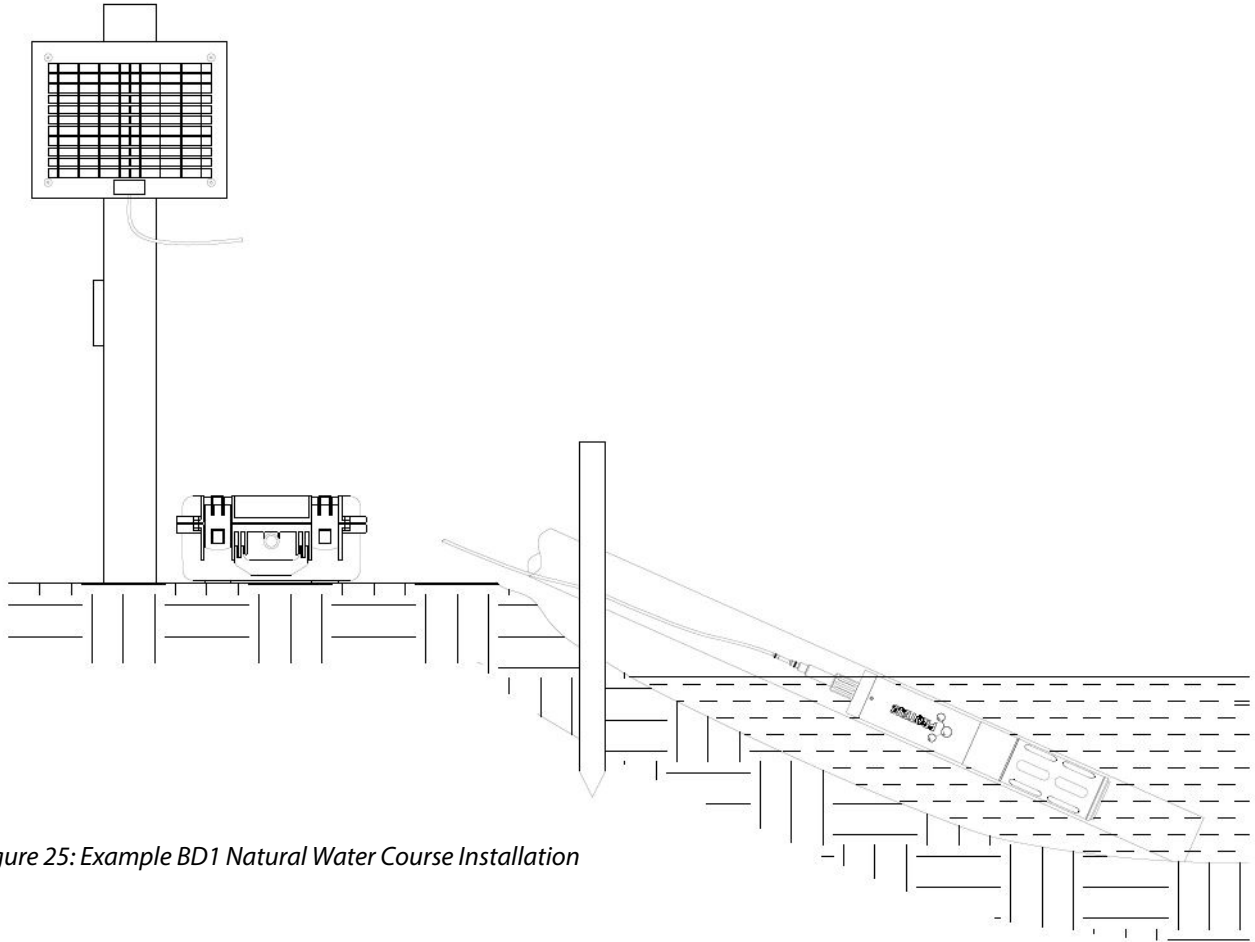

Figure 25: Example BD1 Natural Water Course Installation

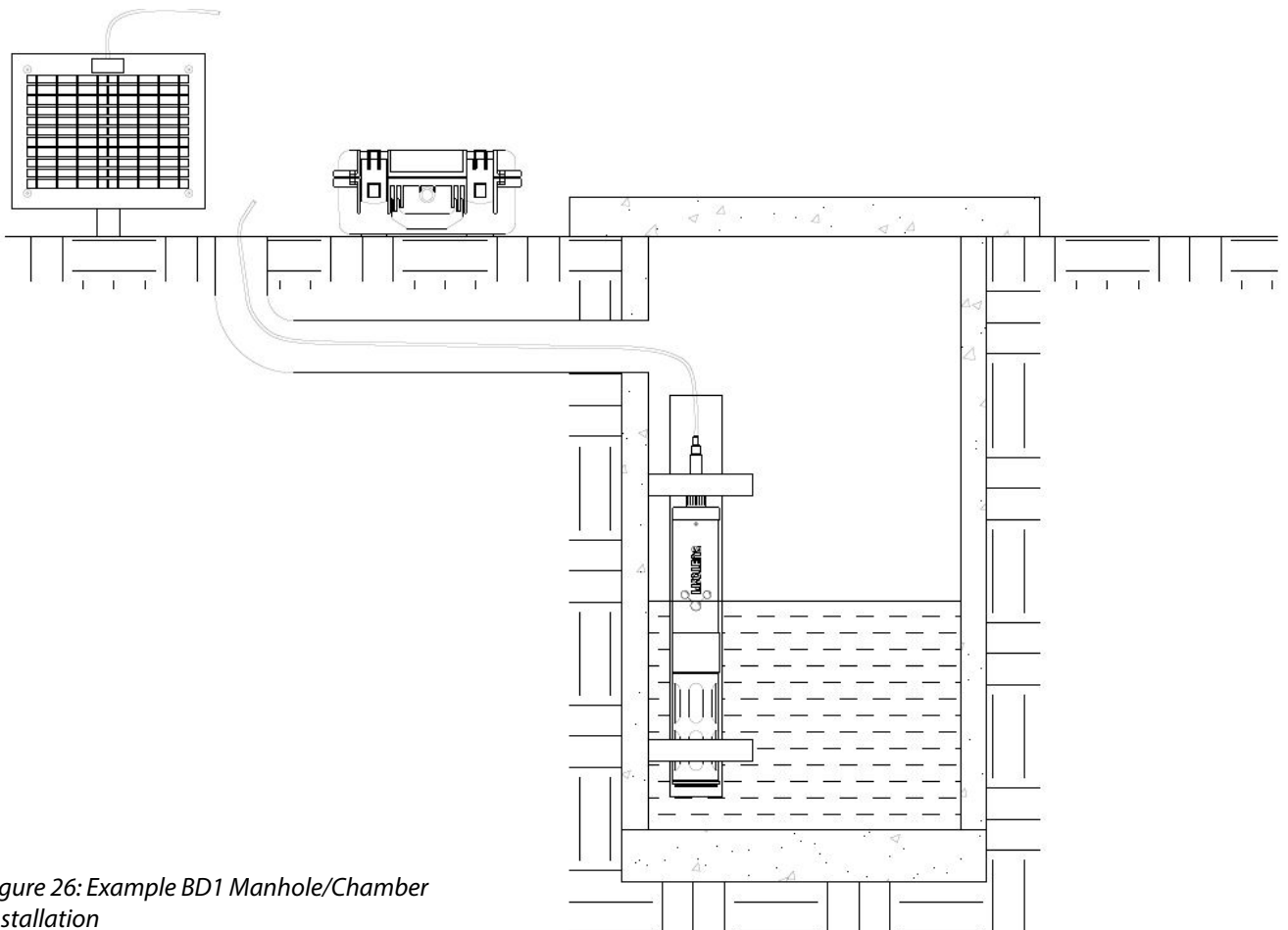

Figure 26: Example BD1 Manhole/Chamber Installation

4.3 BD1 Portable Installation Examples (continued)

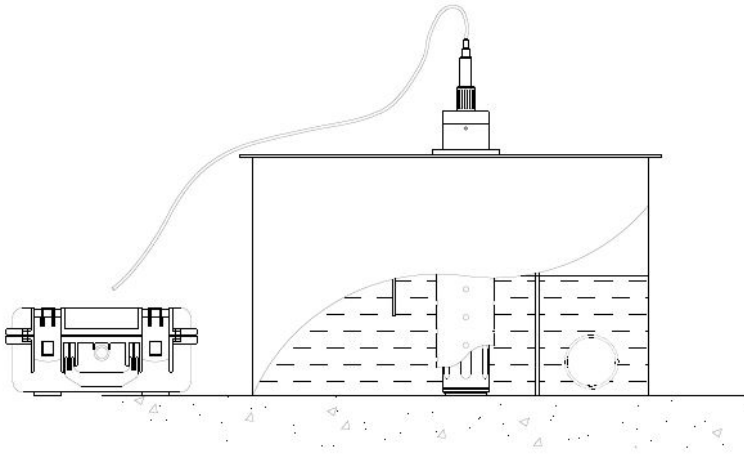

Figure 27: Example BD1 Tank Installation (solar panel not shown)

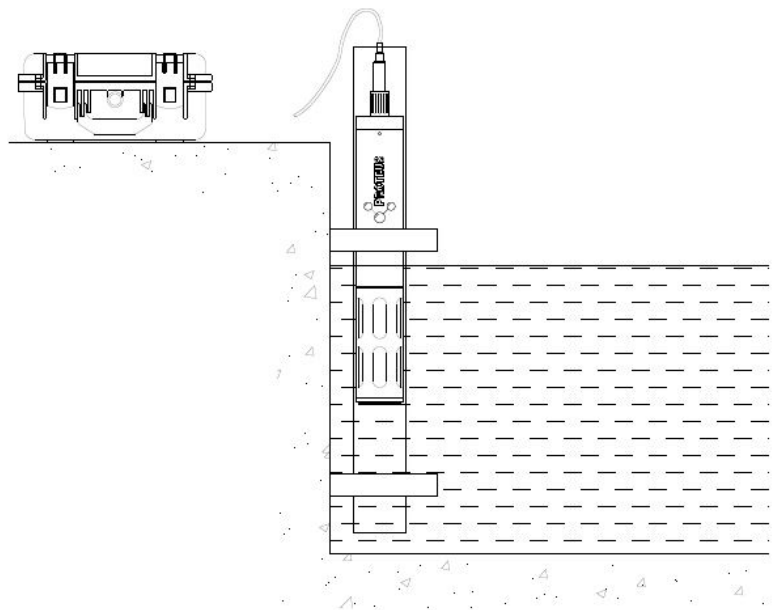

Figure 28: Example BD1 Open Channel Installation (solar panel not shown)

NOTES ON INSTALLATION

Consider

- Access for retrieval of Proteus for calibration & maintenance.
- Mounting to existing structures. i.e. Condition, Fixing method, Permissions.
- Mechanical protection of Proteus cable (Abrasion, Rodent damage).
- Proteus Submersible cable length.
- Solar panel cable length relative to system case.
- Padlock for case.
- Protection and security of system in public spaces.

Note

- Installation arrangement examples shown are not exhaustive.
- Civils works by others e.g Chambers, slabs, tanks.
- Solar panel angle & direction subject to geographical location.
- Following Items are NOT supplied as standard;
Solar Panel Poles, Brackets, Fixings, Stilling Tubes, Posts, Frames

4.4 BD3 Permanent Installation Examples

NOTES ON INSTALLATION

- Uni-Strut® frames where shown. Frames, brackets, fixings and stilling tubes etc. quoted for and supplied on request
- Civils works by others where requires. E.g. Chambers, Slabs, Tanks etc.

Consider

- Access for retrieval of Proteus for calibration & maintenance.
- Mounting to existing structures. i.e. Condition, Fixing type.
- Mechanical protection of Proteus cable
- Power supply

Examples shown are not exhaustive.

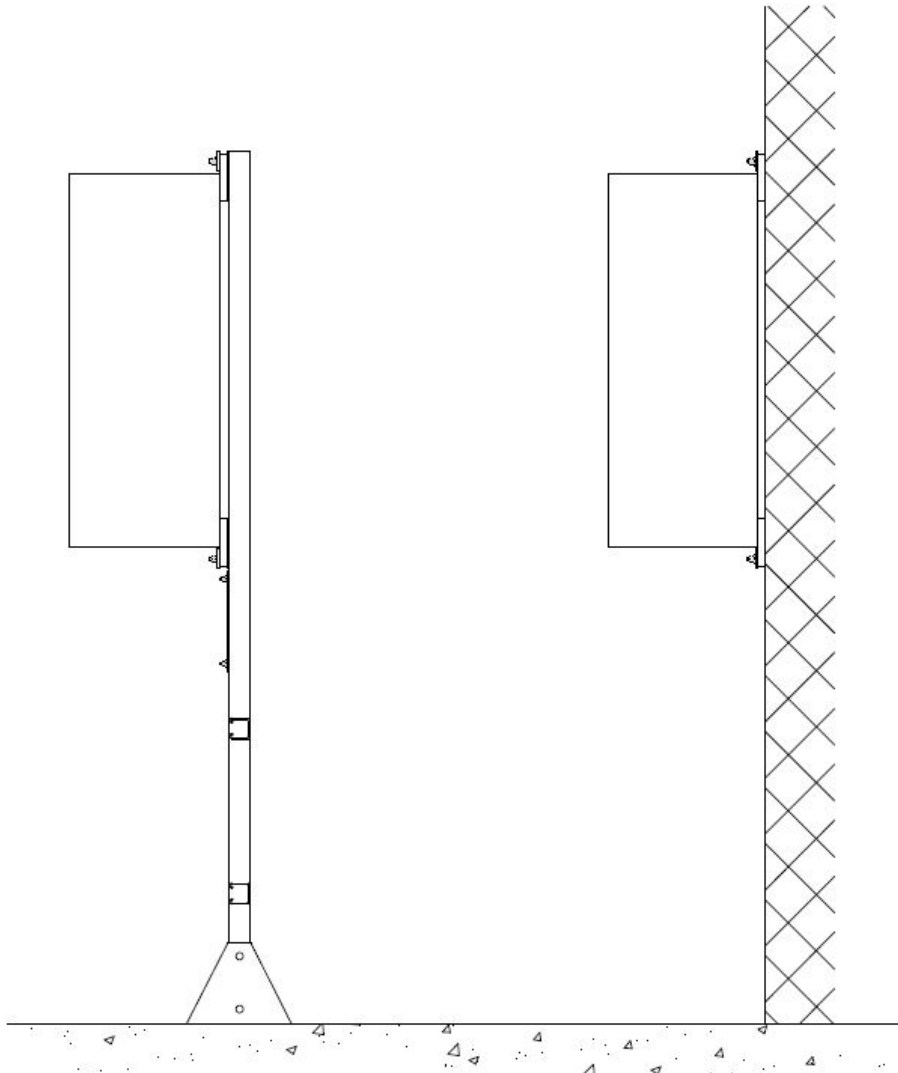

Figure 29: Left BD3 Frame Mounted Example Installation. Right BD1 Wall Mounted Example Installation

4.4 BD3 Permanent Installation Examples

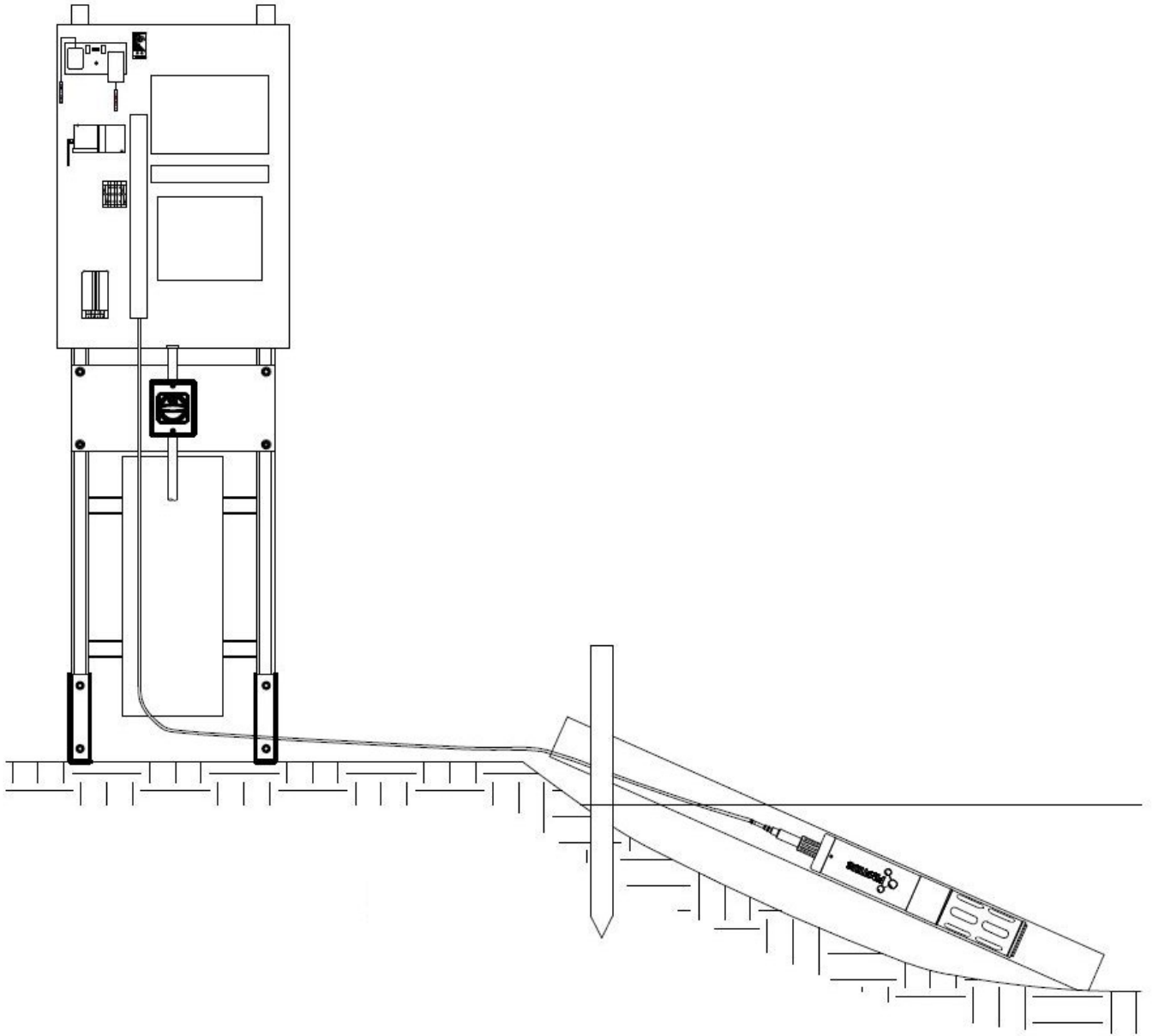

Figure 30: Example BD3 Water Course Installation

4.4 BD3 Permanent Installation Examples

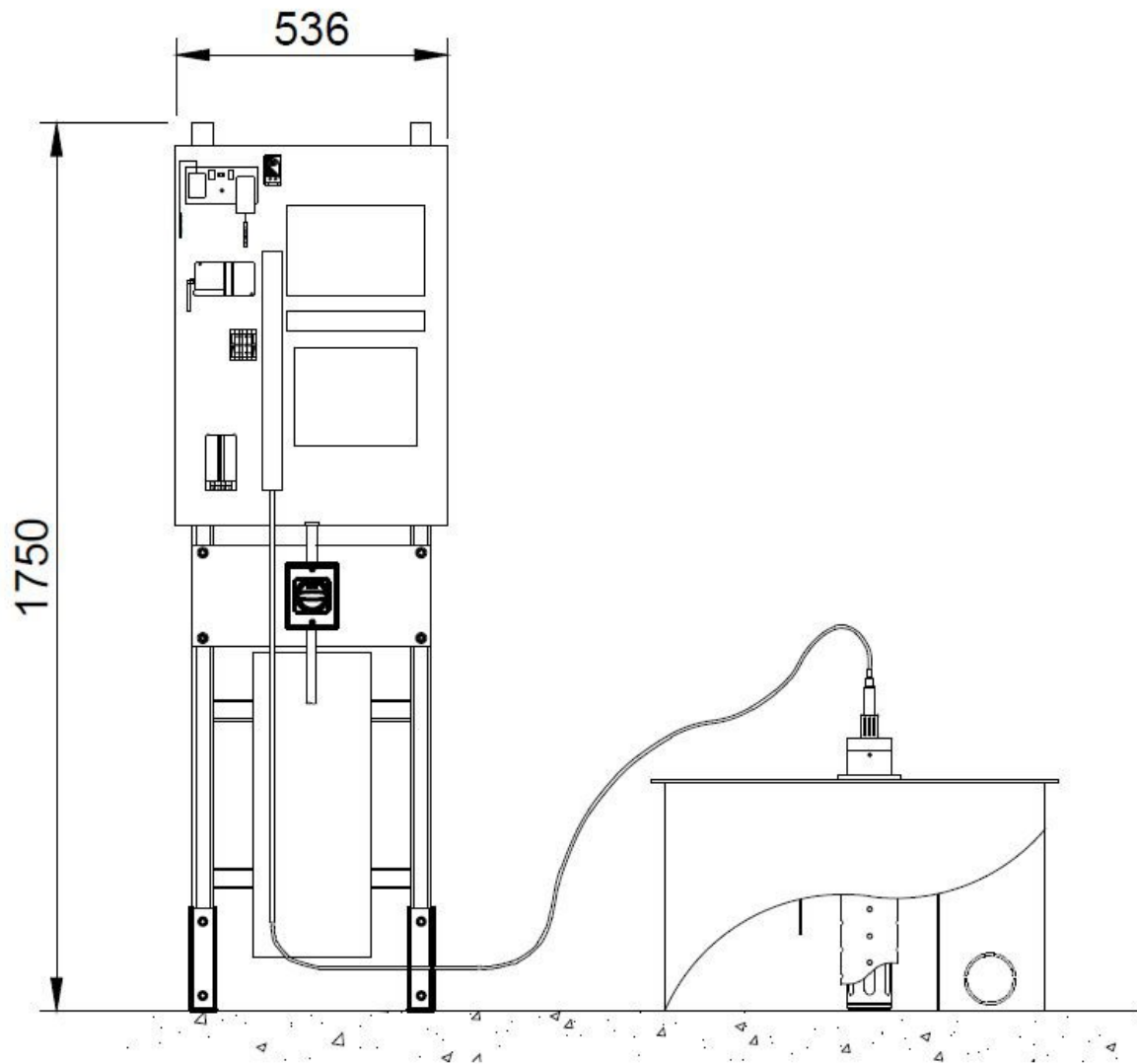

Figure 31: Example BD3 Open/Closed Tank Installation

4.4 BD3 Permanent Installation Examples

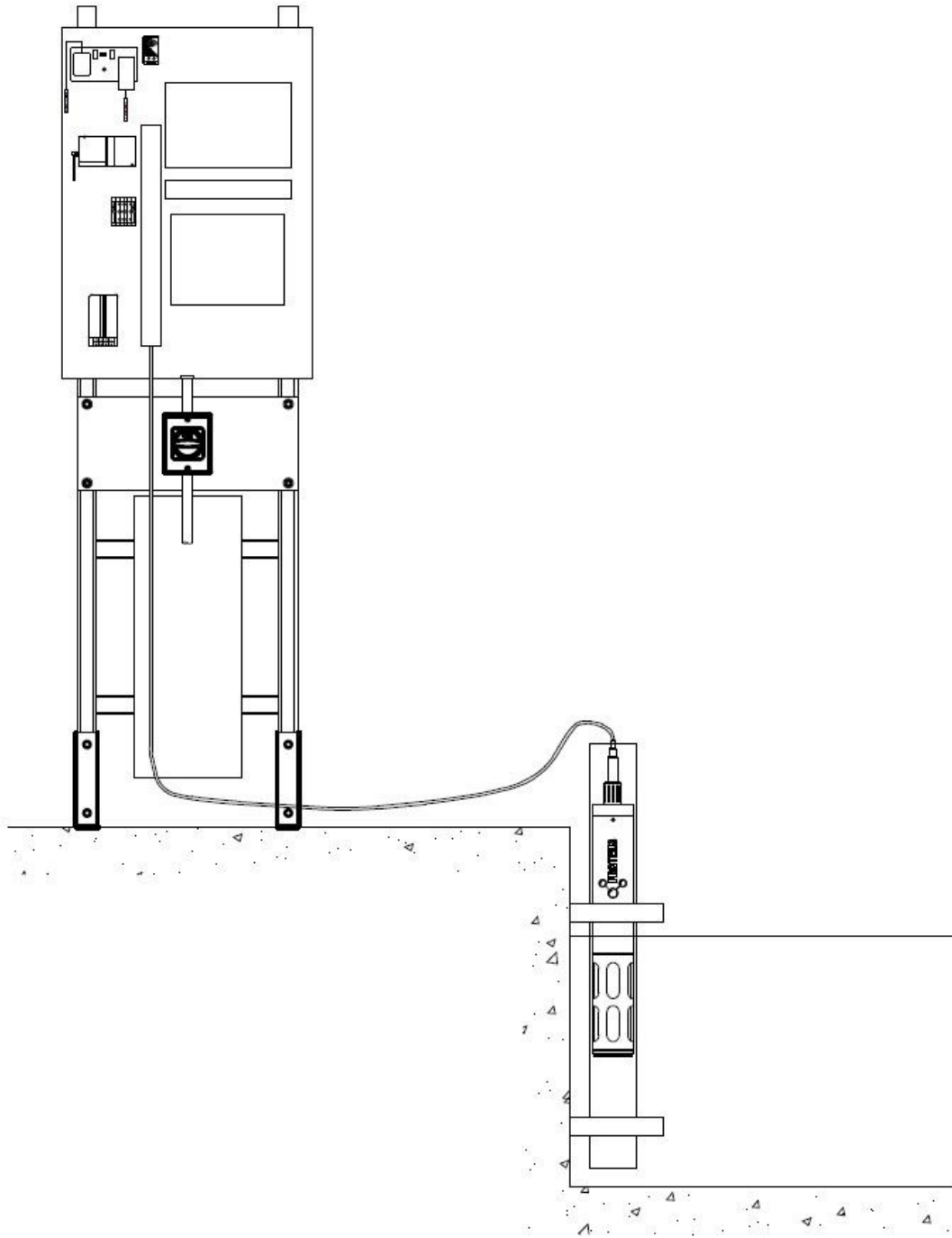

Figure 32: Example BD3 Open Channel Installation

4.4 BD3 Permanent Installation Examples

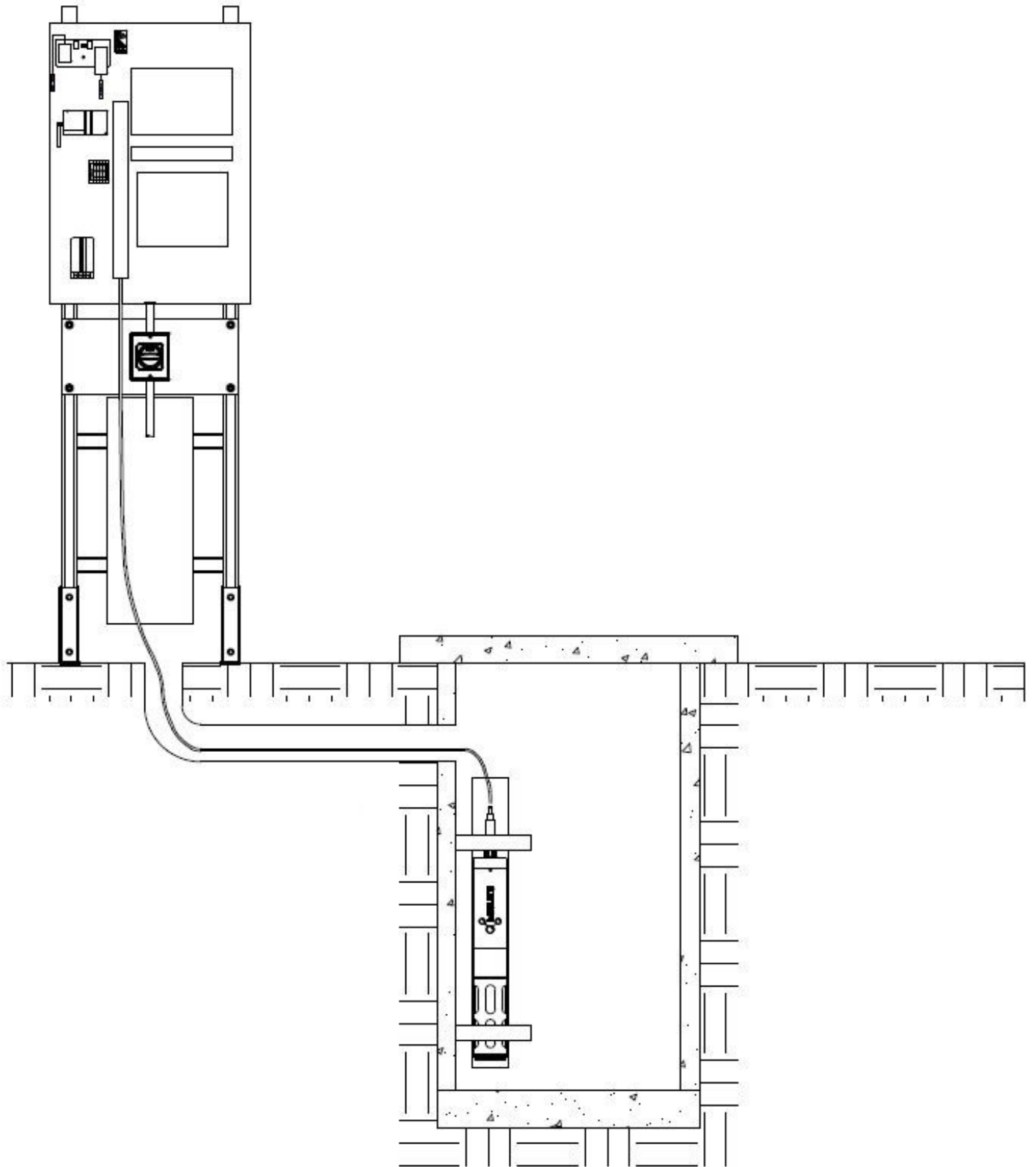

Figure 33: Example BD3 Chamber Mount Installation

5. Maintenance

For cleaning main body and sensors use warm water mixed with a weak acid (0.05M) and a soft bristled brush if appropriate. Do not use industrial cleaners, acetone or abrasives. Rinse well with deionized water; if this is not available then tap water will suffice. The sensor guard can be removed for cleaning but be careful with the sensors when handling the Proteus without the guard in-place.



WARNING

DO NOT LOOK DIRECTLY AT THE LED WHILE THE PROTEUS IS ON.

5.1 Routine Maintenance and Cleaning

To ensure accurate and reliable data during longer term installations, regular cleaning of the multiprobe and sensors is recommended. We suggest that if routine calibration of the sensors is also required that this coincides with your cleaning regime. See Section 6 for more details on calibration.

To a large extent, the integrated wiper will keep the optical windows clear and prevent the build-up of dirt on sensors. However, especially in heavy soiling applications, periodic additional cleaning is recommended to ensure your probe remains in optimal condition. For the first deployment, the instrument should be inspected a minimum of once a week to monitor soiling frequency which should be used to devise a maintenance schedule.

5.2 Turbidity Sensor and Wiper Arm

Turbidity sensors require minimal regular maintenance as the sensor has an automatic wiper for cleaning. The rubber wiper pad and bristles can be replaced, but this is only required every 6-12 months or when the wiper/brush becomes ineffective or worn out. They should be checked for effectiveness as part of routine maintenance; Grit and silt can build-up risking damage to sensor windows.

However, regular checks are recommended to ensure the optical window has not been damaged. Generally, occurrence of damage is low with correct use of the sensor guard. An additional copper gauze can be purchased if biofouling on the sensor is likely to be an issue.

If the lens has become stained and the cause is known, the sensor can be rinsed using a weak acid (0.05M sulphuric acid). This can occur in systems where dosing with chemicals such as ferric-based solutions are common practice. If staining occurs with no known cause, do not attempt to remove it until you are sure of its origin. Occasionally individual bristles can become trapped between the wiper and the turbidity sensor, simply straighten them or carefully trim the overhanging bristles to remedy this. The wiper can deteriorate over time or clog with debris (algae, silt, etc.). The wiper is also supplied with an extended brush arm for cleaning the window of the other optical sensors.

DO NOT MANUALLY FORCE THE WIPER ARM

To Change the Rubber Wiper Pad:

1. Use the hex key provided to loosen the small set screw on the wiper arm (Fig 34).
2. Remove the wiper pad from the wiper arm and replace the pad.
3. Replace the wiper arm on the motor shaft so that the set screw faces the flat spot on the motor shaft.
4. Gently press the wiper pad against the face of the probe until the pad is compressed to roughly three quarters of its original thickness. It is important that the wiper arm does not make contact with the probe face – only the pad should be in contact. A gap of 0.5 mm between the wiper arm and the probe face is typical when a new pad has been installed. Another way of setting the pad gap is to place the pad such that you can slide a small piece of paper under the pad, but snug enough that the pad will hold the paper.
5. Tighten the grub screw.
6. Use the first Allen key from your wiper kit to remove the standard turbidity sensor wiper. Use the other Allen key to install the brush arm. Notice that the Allen grub screw seats on the flat side of the wiper motor shaft.

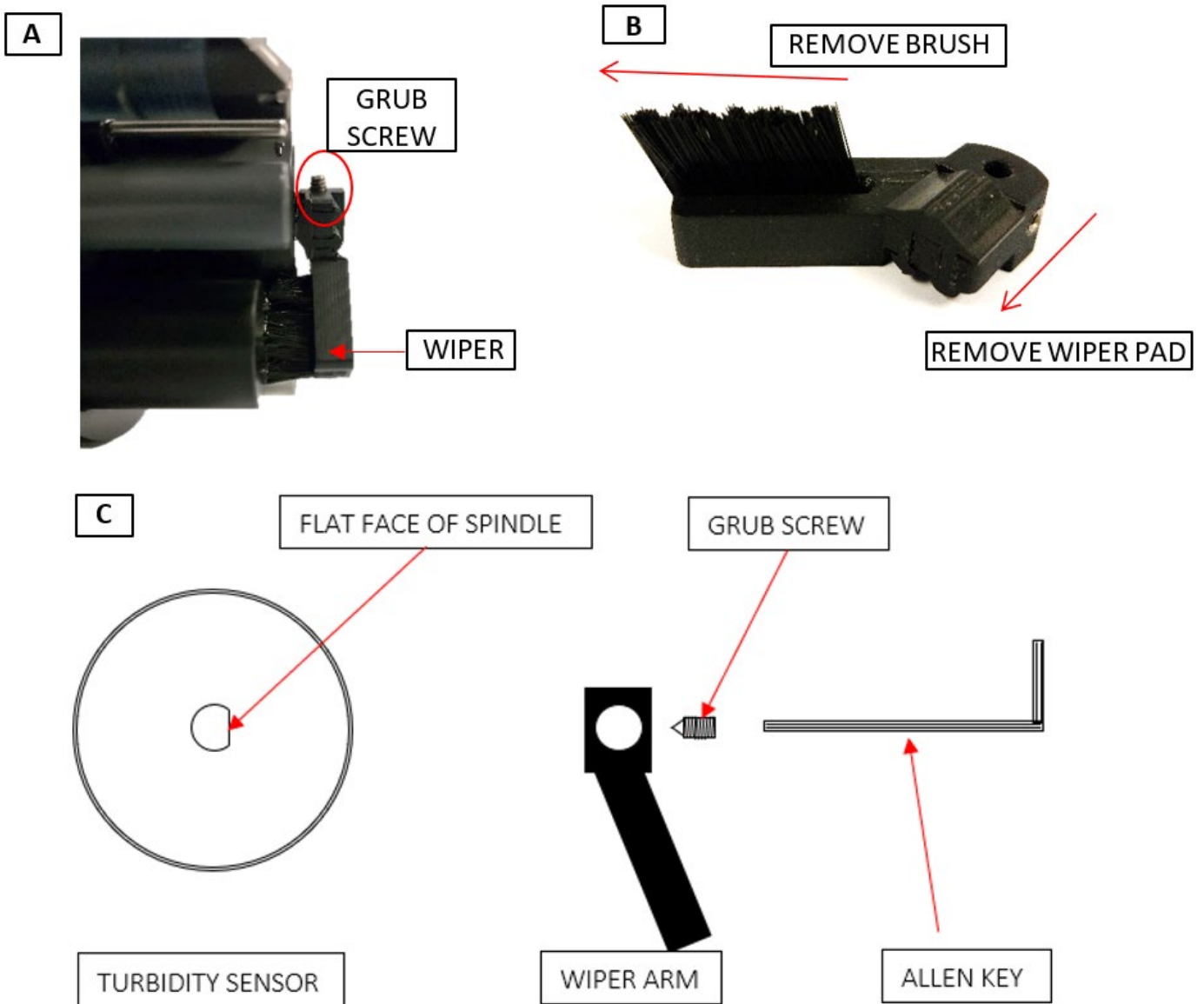

Figure 34:(a) Location of set screw for removing the wiper (b) brush arm with wiper pad and brush highlighted (c) Diagram of the turbidity sensor, grub screw and Allen key.

5.3 Fluorometer Maintenance

Fluorometers should be rinsed or soaked in fresh deionized water following each deployment, until it is completely clean. The optical window should be visually inspected after each deployment following a soaking in fresh water; ensure the sensor is turned off as you should never look as the LED is on.

If cleaning is needed, use optical tissue to clean the window with soapy water, then rinse thoroughly with deionized water. If the lens has become stained and you are aware of the cause, the sensor can be rinsed in a weak acid (e.g. 0.05M Sulphuric Acid). If the cause of staining is unclear, do not attempt to remove it until it has been discovered.

NB: The fluorometer should NOT come in contact with any organic solvents (i.e. acetone, methanol) or strong acids and bases.

5.4 Maintenance of Other Sensors

All sensors should be monitored throughout deployment to ensure they do not become soiled thereby impairing their ability to take readings. Simple rinsing and removal of debris during deployment should be sufficient to maintain sensor health.

Following deployment, the sensors can be cleaned by submerging them in a bucket of deionized water or tap water. Use a soft cloth, or soft bristle brush so remove debris from in-between sensors being careful not to damage the sensor housings or faces. Often simply rinsing the instrument using a bucket of water will suffice but, if you are using a hose, never direct the jet towards the sensors as it can damage the sensor housing and the sensor tips. Generally, you should avoid using pressure washers for this reason; the warranty **will not** cover damage caused by inappropriate cleaning methods. **Do not use pressure washers or similar equipment for this reason;** the warranty **will not** cover damage caused by inappropriate cleaning methods.

Use cotton buds/q tips to clean smaller gaps.

Following any cleaning, rinse the sensors thoroughly in deionised water.

5.4.1 Reference Electrode

Reference electrodes are included with Probes which have pH, ORP or ISEs. The reference electrode is filled with electrolyte fluid (KCl saturated with silver chloride), which should be replaced as part of the maintenance procedure. **On every occasion the cap is replaced, all reliant sensors must be recalibrated.**

1. Remove the reference cap, also known as the Teflon junction, by unscrewing it from the reference sleeve and discard the old reference electrolyte fluid (Figure 35).
2. Fill the sleeve completely with fresh pH reference electrolyte; tap the Proteus gently a few times to dislodge any bubbles.
3. Screw the reference cap back on to the sleeve. As you screw the sleeve into place, both air and excess electrolyte should be forced out of the sleeve through the reference junction (the white, porous circle at the end of the sleeve). This both purges any bubbles and removes any dirt build-up in the sleeve.

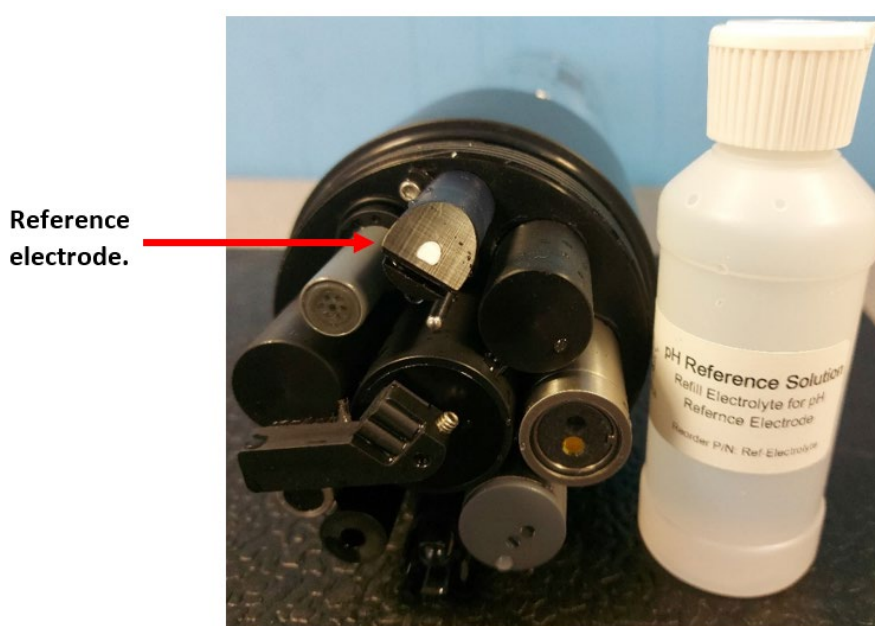

Figure 35: Reference electrode and pH electrolyte solution (provided in maintenance kit).

6. Calibration

6.1 Basics of Parameter Calibration

Calibration is the process by which the individual sensors on the Proteus are 'taught' to equate the matter it is sensing to a number. The raw sensor output for all sensors is millivolts (mV) which is then converted by Proteus into the specified units.

The following is a general procedure for calibration, although it will vary between sensors.

IMPORTANT - Before starting any calibration procedure, ensure all fluids involved have been handled according to Manufacturer's instructions and warnings on MSDS are observed. Correct PPE and disposal methods should also be utilised where applicable.

Calibration should be as thorough and precise as physically possible. The better the calibration is, the more reliable the data reported will be.

1. Cleaning.

- If the unit is being returned following a deployment, it should be cleaned thoroughly before attempting calibration.
- See Section 5 for details.

2. Rinse with Deionised water.

- Fill the calibration cup with a small amount of lab grade deionised water and invert the Probe several times to rinse the sensors thoroughly.
- Once completed, discard the fluid.

3. Rinse with calibration standard.

- Fill the calibration cup with a small amount of the desired calibration standard and invert the Proteus several times, ensuring the sensor to be calibrated is thoroughly rinsed in the fluid.
- Once completed, discard the fluid.
- Repeat this step at least twice to reduce the chance of accidental dilution.

4. Fill with calibration standard.

- Fill the cup with the desired calibration standard, ensuring the top of the sensor being calibrated is covered by the standard.
- This can be done by either inverting the Proteus, or laying it on its side.

5. Exceptions.

- The turbidity sensor must be submerged so that there is a minimum fluid blanking distance above the optical window of 40 mm.
- Fluorometers cannot be calibrated using the calibration cup as they require a minimum blanking distance of 20 cm. Please refer to Section 6.8 for calibration specifics.
- ISEs and the pH sensor also require the reference electrode to be submerged during calibration.

For Custom Parameter calibration, see Section 3.4.3.

6.1.1 Calibration step-by step guide

1. Select parameter to calibrate by navigating to the Proteus menu → Calibrate → Select parameter from drop down list.

NB: This list shows all the possible parameters that are available for Proteus, however, you can only calibrate those sensors fitted to your Proteus.

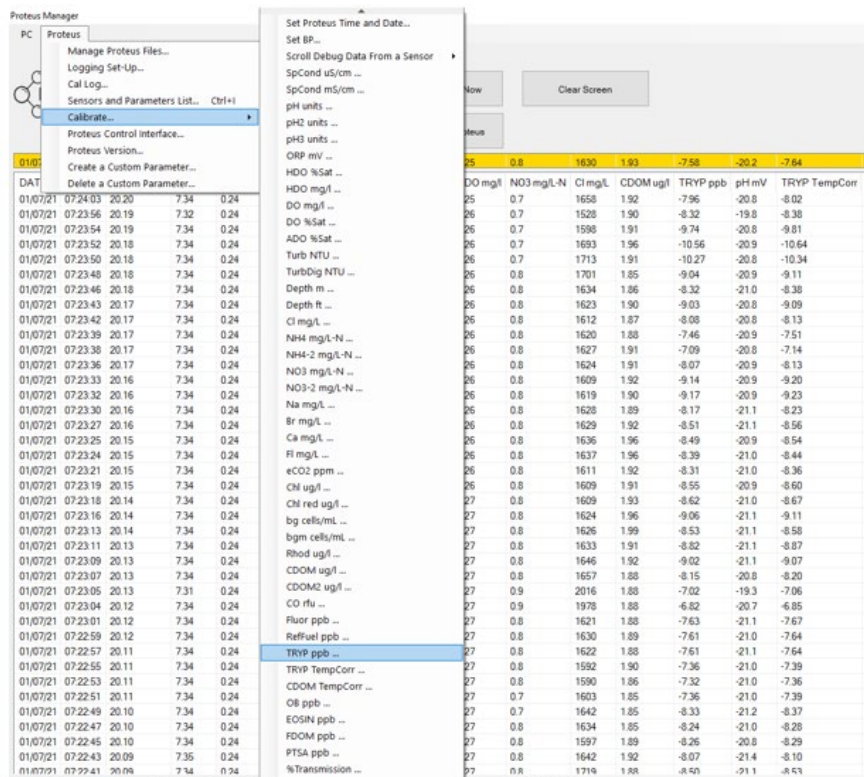

Figure 36: Proteus Calibration Parameter List.

2. A pop up will open; enter the calibration value and wait for the reading to stabilise

Calibrate Sensor TRYP ppb

Type the value of your non-zero calibration standard, and pour that standard into the Manta 2 calibration cup.

01

OK when the sensor reading is stable:

2.69

Help Quit OK

Enter the **value of the standard** in this box.

This box shows the value the sensor is currently reading and is **not representative of accuracy** until the calibration is completed. When the reading is stable select 'OK' using the button underneath.

The graph is a visual representation of the sensor reading. During calibration, allow the line to travel the full length of the graph before accepting a calibration point.

Figure 37: Proteus calibration window.

3. If the calibration has more than one point, the software will prompt you to continue or accept.

6.1.2 Calibration Troubleshooting

- **Some sensors require longer to stabilise than others.** Particular care should be taken to minimise stabilisation time with turbidity and fluorometer calibrations as the matter will settle out which can harm the accuracy of the calibration. In contrast, ISE sensors should ideally be 'soaked' in the higher calibration standard for 5mins prior to calibration of the sensor.
- If you press 'Quit' at any point in the process, none of the data will be saved and the calibration will have to be started again.
- Upon accepting the final calibration point, the reading in the software will automatically refresh and the newly calibrated reading will appear after the pop-up is closed.
- Some sensors will also show a Sensor Response Factor (SRF) after acceptance but before the window is shut, see Section 6.4 for more details.

6.2 Choosing Calibration Standards

To achieve the best accuracy in the field, a standard should be used which is close to the expected field value. This is easiest to do if there is pre-existing data for the site of interest however there are also widely available standards if there is no data available. For example, parameters such as Specific conductance (1-point calibration) have various fixed standards which are environment specific (Table 4).

If you are using the Proteus across multiple environments it is recommended that you recalibrate to accommodate the change in environmental characteristics. For example, if you are moving the Proteus between a WWTW inlet and final discharge, the turbidity calibration should be altered to reflect the two different environments.

The recommended calibration intervals are as follows:

Fluorometers - 6 -12 months

Turbidity - 3 - 6 months

ISEs - 6 weeks (max)

Other sensors 3 months

Calibration intervals may vary according to the application and required accuracy, and may be required more or less often than stated above.

Table 4: Information on Calibration standards. NB: 'BP' stands for Barometric Pressure.

Sensor	Standard Method of Calibration	Available Calibration Solutions	Additional Comments
Temperature	Never requires calibrating		
Reference Electrode	Never requires calibrating		Replace pH electrolyte solution during routine maintenance.
Depth	Adjust for BP	N/A	Adjust at deployment site for best accuracy
pH/pH reference	2/3 point	pH 4, pH 7, pH 10	pH 7 and pH 10 most common
ORP	1 Point	ORP standard 200 mV	
Conductivity	1 Point	CD Standard, 0.5 Molar, 111800 μ S	Brackish/saltwater
		CD Standard, 0.1 Molar, 12800 μ S	Borderline brackish
		CD Standard, 0.01 Molar, 1413 μ S	Freshwater- very pure
		CD Standard, 0.001 Molar, 147 μ S	Fresh/glacial
Turbidity	2 Point	100 NTU, 500 NTU	Calibrate near expected value
Optical DO (ADO/HDO)	Calibrate at 100% saturated water	Tap water – shake vigorously to oxygenate	Set BP before calibrating, recalibrate at deployment site for best accuracy
Ion Selective Electrodes			
Ammonium (NH ₄ ⁺)	2 Point	Ammonia Monitor Standard 5ppm and 50ppm	Use most applicable calibration standard range.
Chloride (Cl ⁻)	2 Point	CD Standard 147 μ S CD Standard 1413 μ S	Enter 34.3 mg/L during low end calibration and 319.3 mg/L for high end calibration
Nitrate (NO ₃ ⁻)	2 Point	Nitrate Monitor Standard 4.62 ppm and 46.2 ppm. KNO ₃ based standard.	Use most applicable calibration standard range.
Sodium (Na ⁺)	2 Point	Sodium Standard Solution 5ppm and 50ppm	Dilute with de-ionised water to 5ppm and 50ppm from 1000ppm stock solution
Calcium (Ca ²⁺)	2 Point	Calcium Calibration Standard	Use most applicable calibration standard range.
Bromide (Br ⁻)	2 Point	Bromide Calibration Standard	Use most applicable calibration standard range.
Fluorometers			
Tryptophan-Like Fluorescence	2 Point	Synthetic Tryptophan stock solution of desired concentration. DI water	Details in Section 6.2.1
Chromophoric Dissolved Organic Matter (CDOM)	2 Point	Quinine sulphate standard 100 μ g/l Or PTSA Standard	Quinine sulphate standard composed of Quinine Sulphate dihydrate and 0.05M sulphuric acid (See safety notes)*
Chlorophyll	2 Point	Secondary solid or liquid standard or lab sample	Blue excitation can be calibrated using Rhodamine WT 400 ppb = 40 μ g/L
Rhodamine	2 Point	Secondary solid standard or Rhodamine WT	
Blue Green Algae (Phycocyanin and Phycoerythrin)	2 Point	Rhodamine WT (RWT)	Phycocyanin (PC) 200 ppb RWT = 260 ppb PC
			Phycoerythrin (PN) 50 ppb RWT = 500 ppb PN
Refined Oil	2 Point	PTSA Lab standard	
Crude Oil	2 Point	NDSA Lab Standard	
Fluorescein Dye	2 Point	NDSA Lab Standard	
Optical Brighteners	2 Point	NDSA Lab Standard	

6.2.1 Tryptophan Stock Solution

The Tryptophan stock solution can be used to calibrate the tryptophan fluorometer. Each stage must be carried out carefully to ensure accuracy. Please note, the stock solution must be diluted before calibration, it cannot be used at the concentration it is made; see Section 6.8 for instructions.

Equipment Required:

- 1 x 1 litre volumetric flask
- 1 x 2 litre beaker (Borosilicate recommended)
- 1 x Magnetic stirrer or other automatic stirrer
- 1 x Synthetic L-Tryptophan powder (laboratory grade)
- 1 x 1 litre of Lab grade, ultra-pure deionised water
- Precision weighing scales, capable of 0.001g accuracy.

Method:

1. Accurately weigh out 0.2g of L-Tryptophan Powder.
2. Add the L-Tryptophan powder to an empty and clean 1 litre Volumetric flask.

TIP: Use a squeeze bottle filled with Ultra-Pure Deionised Water to rinse the Tryptophan powder from the boat and inner surfaces of the flask neck, ensuring all powder enters the main bulb of the flask.

3. Accurately fill the flask to the 1 litre mark with Ultra-Pure Deionised water.
4. Place the flask on the magnetic stirrer. Carefully add the stirring bean and switch on the stirrer to fully dissolve the powder in the water. This may take 20mins.

Add the bean after the flask has been filled with water in stage 3 to account for displacement.

This 1Ltr of stock solution has a Tryptophan concentration of 200mg/L or 200,000 ppb.

Where:

100mg (0.1g) L-Tryp powder in 1 litre = 100mg/L or 100,000ppb

Therefore:

200mg (0.2g) L-Tryp powder in 1 litre = 200mg/L or 200,000ppb

This Stock solution should be kept refrigerated and can expect to last 1 week

Making smaller volumes requires very small amounts of powder which will significantly increase the risk of error in the final concentration value.

CDOM Stock solution can be made using the exact same method, simply substitute L-Tryptophan powder for Quinine Sulphate Dihydrate. ***(IMPORTANT - Please read the Suppliers Safety Data Sheet and take appropriate safety measures when using these chemicals.)**

6.3 The Calibration Log

Every Proteus has a dedicated internal data file called 'CAL LOG', located via the Proteus drop down menu (Figure 13). The CAL LOG records every calibration that your instrument has accepted. The full information provided in the CAL LOG can be seen in Figure 38, and the log will include both successful and unsuccessful calibrations. The CAL LOG can be used effectively to understand sensor behaviour and rate of drift (if applicable).

Date	Time	Sensor	SN	Units	RV	Old	New	SRF
04/30/19	18:22:33	TURB	4193730	NTU	2.21E-02	-1.56	0	100

Figure 38: An example line from a Proteus calibration log showing a 0-turbidity calibration.

SN = Serial number, RV = Raw voltage, 'Old' refers to the reading pre-calibration and 'New' to the reading post calibration.

6.4 Sensor Response Factor (SRF)

Also included in the Calibration Log is a Sensor Response Factor (SRF) (Figure 39). The SRF is a numerical value that is provided by the instrument to indicate how well the sensor is responding. An SRF between 80 and 120 is good. If the SRF falls between 60 to 140 it should be investigated for sensor functioning but may still be acceptable. If your SRF is outside those limits, check your standard value and the maintenance condition of your sensor. In addition, each sensor calibration's Sensor Response Factor (SRF) is automatically logged into the CAL LOG with the details of that calibration; this can also be checked if you are concerned about the SRF reported to compared to previous calibrations.

Figure 39: Sensor Response Factor Pop-Up

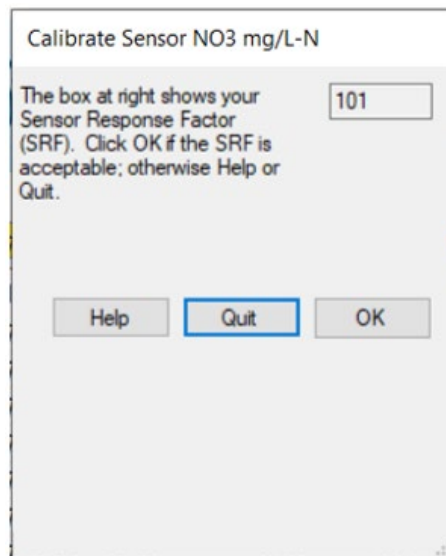

6.5 Units/Conversion Factors

Fluorescence: the units reported are ppb (ppb = $\mu\text{g/l}$). However, the raw fluorescence output is preferred (i.e. mV) then this can be provided as an additional parameter.

Temperature: the units reported are $^{\circ}\text{C}$ ($^{\circ}\text{F} = ^{\circ}\text{C} \times 1.8 + 32$; $\text{K} = ^{\circ}\text{C} + 273.15$).

BOD equivalent: the units reported are mg/L.

COD equivalent: the units reported are mg/L.

DOC/TOC: the units reported are mg/L.

Coliforms (all types): units reported at cfu/100ml.

6.6 Factory Calibration for Derived Parameters

The sensor is initially programmed with a 2-point factory calibration for both the turbidity sensor and any fluorometers present. Coefficients are then applied to achieve the derived parameters; the coefficients are generic based on most similar application which is why they should be followed up with a site-specific calibration to achieve maximum accuracy. For full details on site calibrations, see Section 6.9.

For turbidity, and other parameters where applicable, custom calibrations can be provided upon request. You may wish to consider a custom calibration under the following conditions:

- A larger range is required than typically offered or more calibration points across a specified range.
- A calibration using a matrix water dilution series.
- A calibration with user specified standard material, for example, the turbidity sensor is typically calibrated using Formazin standard but could also be calibrated with polymer beads.

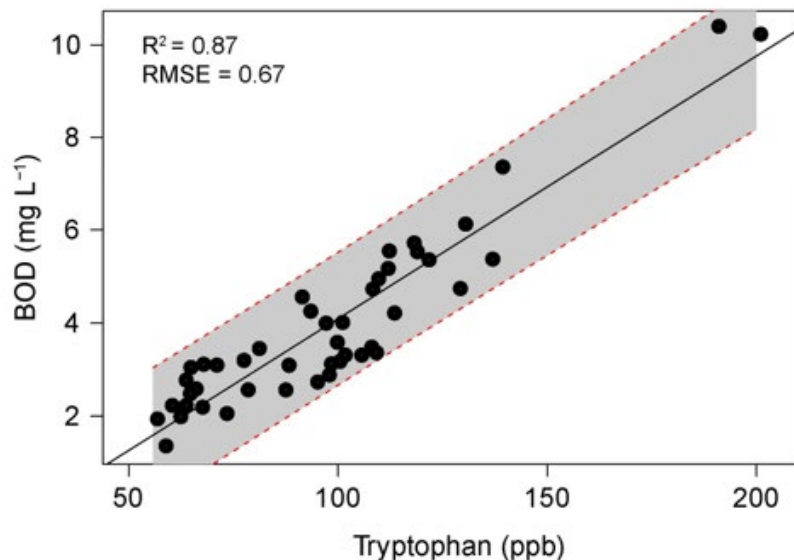

Figure 40: Proteus instruments default low range relationship (turbidity and temperature-corrected tryptophan).

6.7 Turbidity Calibration

Turbidity is measured as the fraction of an infrared light beam that is scattered at 90° to that beam. The more particles that are in the water cause more light to be scattered, and therefore the turbidity reading increases. The turbidity sensor cannot distinguish between particles in the water and any that have accumulated on the sensor window. Therefore, the in-built wiper should be triggered before each reading to ensure a clear optical window.

DO NOT MANUALLY FORCE ROTATE THE WIPER ARM.

Turbidity uses a two-point calibration; one point is zero turbidity and the other point should be a standard approximating the maximum turbidity of the water you intend to monitor.

Make sure you use enough calibration standard to cover the sensor's "optical volume" – a distance of >70mm is adequate. Calibration should be undertaken in a dark, non-reflective container. Do not allow the particles in the fluid to start settling as this will result in an inaccurate calibration. Agitate the calibration container to prevent settling and accept the reading as soon as it is stable to prevent settling.

Ensure the sensor is properly rinsed with the fluid before starting calibration and follow the on-screen instructions guidance provided in Section 6.1.

6.8 Fluorometer Calibration

Calibration of the fluorometers requires a slightly different procedure to the other sensors as they need to be calibrated in darkness to avoid light interference. In addition to the procedure detailed in Section 6.1, the following considerations should be noted:

Fluorometers must be calibrated in the dark, in a non-reflective container.

Avoid using plastic as this can fluoresce, a glass beaker wrapped in a black cloth on all sides will be suitable.

There must be a minimum blanking distance of 10cm (vertical) and 10 cm (horizontal) between the sensor and the sides of the container to prevent light reflection. See Figure 41.

The Proteus must be suspended in direct contact with the liquid, without the calibration cup or sensor guard. The Proteus must be suspended perfectly vertically as any degree of tilt can cause readings to fluctuate, potentially resulting in an inaccurate calibration.

There should be no bubbles in the fluid or on the optical lens of the fluorometer.

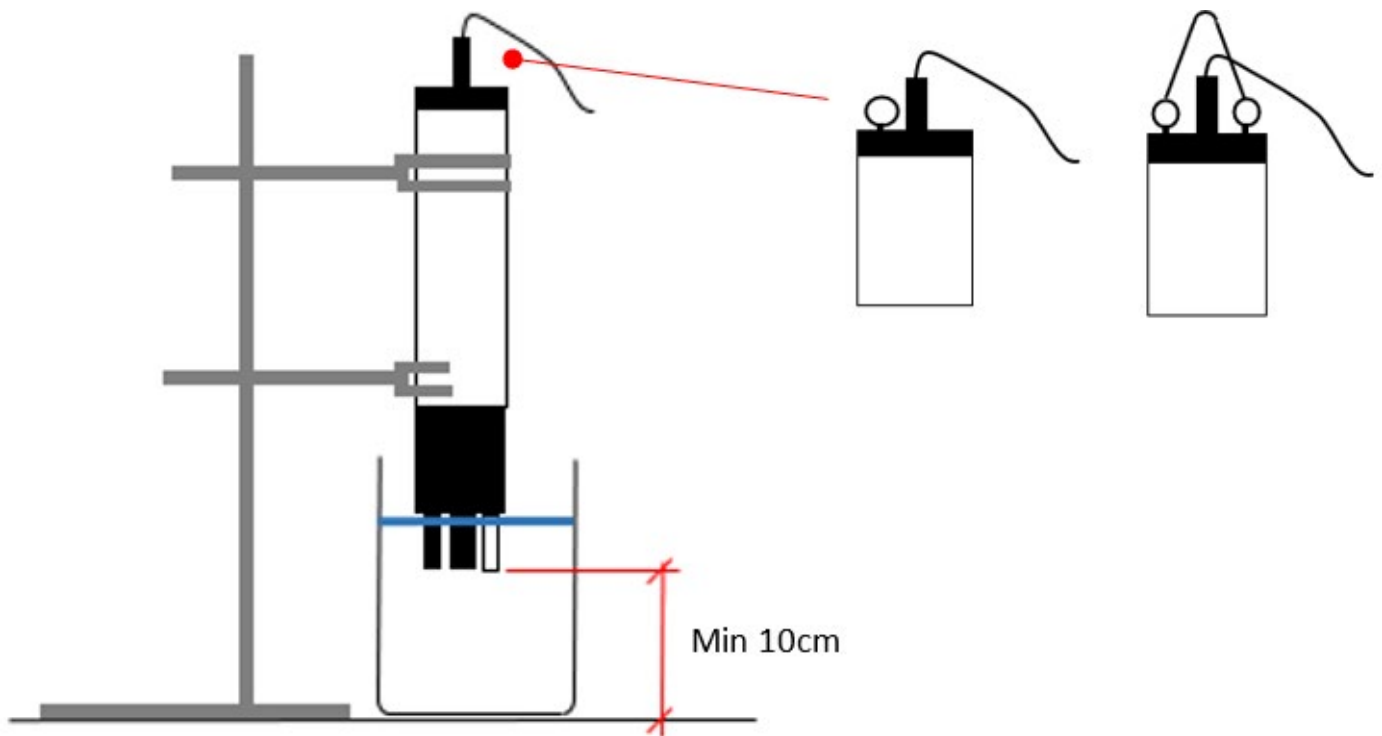

Figure 41 - Calibration set-up for fluorometer calibration.

The Proteus can be suspended in solution via a clamp or by using eyebolts if equipped (inset image).

The image does not depict the required black covering around the container to allow for other features to be communicated. The black, non-reflective covering should be used on all sides.

If you are using the stock solution recipe (Section 6.2.1.), use a pipette to dilute 1 ml of stock solution into 2l of Ultra-pure deionised water; this produces a calibration solution of 100 ppb.

We have individual calibration SOPs available on request. You can also watch our video:

<https://www.youtube.com/watch?v=YNuPSZqT4EY&t=14s>

6.8.1 Typical Tryptophan Ranges and respective BOD

Below is an advisory guide as to different environment's typical TLF concentration and the respective average BOD ranges.

Table 5: Guidance on average BOD ranges.

HABITAT	TRYPTOPHAN-LIKE FLOURESCENCE	BOD5
Rivers	20-60ppb	0-5 mg/L ⁻¹
Treated effluent and polluted rivers	20-1500ppb	5-60 mg/L ⁻¹
Primary/Secondary effluent	50-6000ppb	40-300 mg/L ⁻¹
Raw municipal sewage	100-12000ppb	100-600 mg/L ⁻¹
Contaminated industrial effluent	800->10000ppb	400-6000 mg/L ⁻¹

6.8.2 Temperature Compensation

Fluorescence is a temperature sensitive measurement as at higher temperatures the signal is 'quenched' or attenuated (see figure 42 for example). The fluorescence signal is also corrected for temperature quenching allowing the user to measure uncompensated and compensated fluorescence.

The Proteus is placed in the solution to be measured and warmed and cooled across the range expected during field monitoring (usually 5 - 25 °C). Readings are then logged and the readings are then used to create a regression relationship between temperature and tryptophan like fluorescence. The ratio of the slope: intercept (ρ) has been shown to be relatively constant regardless of fluorophore concentration and thus provides a robust temperature compensation coefficient.

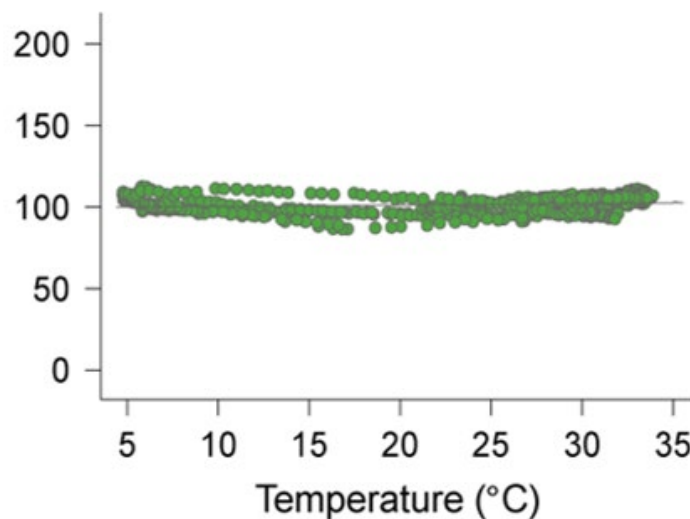

Figure 42: Temperature-compensated TLF of a laboratory standard.

6.8.3 Tryptophan Turbidity Compensation

As with any optical measurement the accuracy of the measurement is dependent on the clarity of the sample volume. In the case of tryptophan like fluorescence we observe both amplification and attenuation of the signal depending on the number of particles suspended in the water column. At very high concentrations of suspended particles (i.e. turbidity > 300NTU) attenuation of the signal becomes significant whilst amplification is most pronounced between 30-100 NTU (Figure 43).

Proteus Instruments have developed and patented robust laboratory-based compensation algorithms that can be employed to correct for influence of turbidity. However, as particle size can influence the response the fluorescence sensor exhibits it is important to know some information about the sediment dynamics in your study catchment. Alternatively, a site specific, field-based calibration can be constructed between BOD and tryptophan like fluorescence can be established (See Section 6.9). This compensation factor is optional and is advised when highly variable fluorescence dynamics are anticipated or when the fluorescence signal is of interest rather than the calibrated BOD reading.

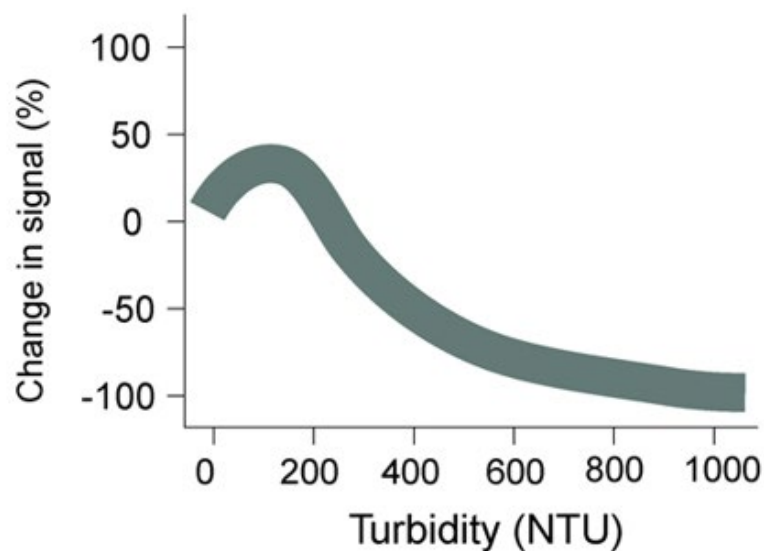

Figure 43: Change in fluorescence signal with turbidity.

6.8.4 Verification and Calibration

The optical sensors in the Proteus should display minimal drift, however we recommend routine verification with a blank in the field.

6.9 Site-specific Calibration

For accurate and repeatable measurement of any of the derived parameters, a site-specific calibration is recommended. This should ideally encapsulate a high flow event when rapid changes in turbidity (sediment concentrations) and organic matter loadings are likely to occur. Proteus Instruments can offer rental of refrigerated pump samplers (ISCO Avalanche) for storm sampling. These samples have to be **taken simultaneously with the Proteus readings in the same location**. Collected samples can then be processed at an accredited laboratory. *If you require additional information regarding correct sampling procedures, we can provide instructions.*

We require a minimum of 15 paired samples (2 x 15 samples = 30 samples total) across the entire measurement range of the conditions expected. For example, if you are monitoring coliforms where the day-to-day average is 1-3 cfu/100 ml, but during storms this increases to 100+ cfu/100 ml, you should aim to start sampling before a forecasted storm and continue to sample through the rising limb to the point at which coliforms peak. You can, of course, sample beyond this but as a minimum, the entire range must be covered.

Alternatively, a generalised relationship between temperature/turbidity corrected tryptophan-like fluorescence (or other fluorescence) and the derived parameters can be used. However, it is important to note that these have been derived from studies on a subset of all possible applications so will act as more of an indicator of organic enrichment rather than a quantitative measurement of the derived parameter. See below (Figure 44) for the generalised relationships based on samples collected from agricultural and urban river systems.

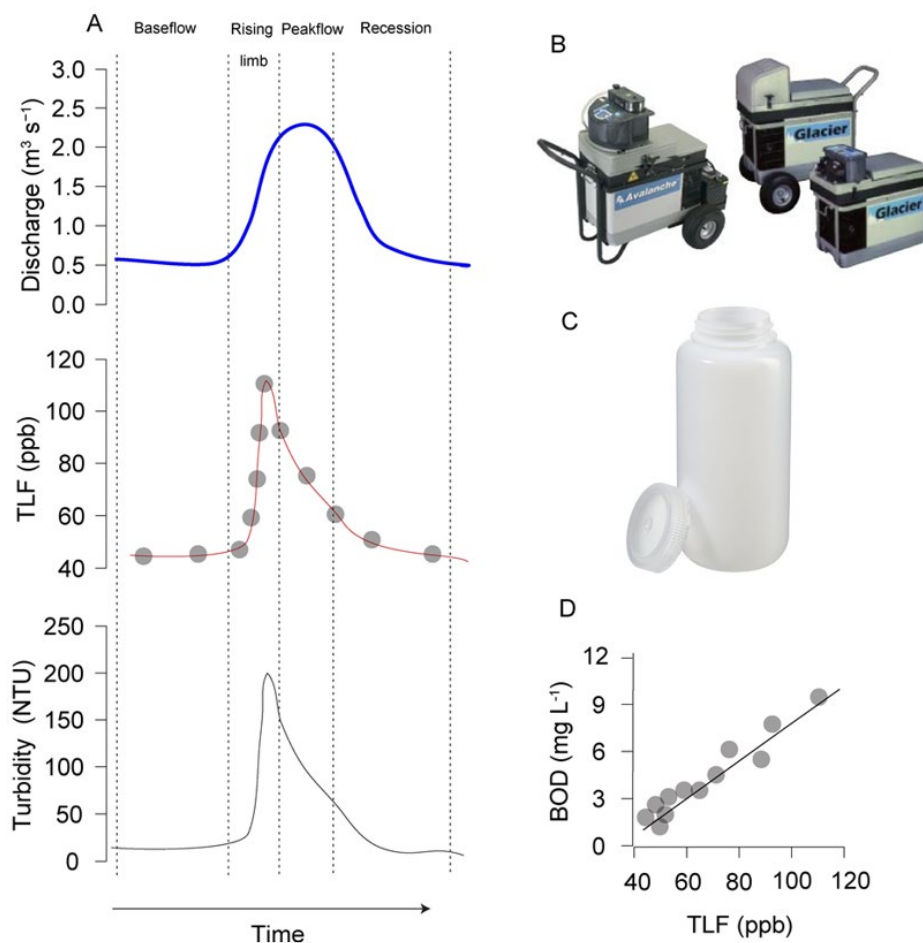

Figure 44: Schematic of a site-specific calibration procedure.

A. Displays the components of a storm hydrograph. To ensure a good calibration it is important to sample at a range of points in time across the hydrograph to get a wide range of TLF values and turbidity readings.

B. Displays the automatic pump sampler Proteus Instruments can provide for sampling storm events.

C. If users do not have access to lab facilities Proteus Instruments can arrange for BOD sample bottles to be delivered and collected after sampling and analysis then conducted in an accredited laboratory.

D. A site specific BOD- TLF relationship can be established and real-time continuous measurements of BOD can be provided.

6.10 Proteus Spike Testing – Simulating a pollution event in the lab

Overview:

Spike testing involves adding a high concentration pollutant (e.g. untreated sewage), to background uncontaminated application water at increasing concentrations. Paired Proteus readings and lab samples should be taken at each concentration, with lab samples analysed in replicate for each parameter of interest.

The results will give both an indication of Proteus sensitivity to organic contaminants and facilitate a clear comparison with the resultant lab values. This data can contribute to generation of a custom local site calibration which reflects the range for the system of interest.

It should be possible to complete the spiking and paired sampling in less than one day. Lab sample analysis time is based upon the laboratory testing protocols used. Samples should be stored at 4 degrees centigrade prior to laboratory analysis to ensure sample integrity. Analysis should begin ASAP following paired sampling to avoid error propagation and ensure accurate comparison with Proteus values.

All laboratory samples should be immediately decanted into clean bottles and refrigerated after stable readings have been logged by the instrument to ensure consistency of results.

The accompanying spreadsheet: Spiking Template.xls can be used for determining the volumes and concentrations required. The volume can be adjusted in the Spiking Template spreadsheet depending on the laboratory testing requirements.

Required equipment:

- DI H₂O.
- 5L glass beaker (minimum dimensions – internal diameter 15cm borosilicate glass).
- Magnetic stir plate and bar.
- High accuracy pipette for measuring 0.25-1 mL of fluid.
- Clamp and stand for positioning Proteus (to save manually holding instrument for readings).
- Proteus connected via PC comms cable to computer running Proteus manager software:
<https://proteus-instruments.com/software>
- Suitable, clean bottles for decanting samples for laboratory analyses.
- Waterproof labels/pen for sample ID on bottles.
- Further DI H₂O for equipment rinsing.

Instrument set-up:

1. Connect PC communications cable to Proteus and RS-232 to USB converter to PC USB port.
2. Once the Proteus is plugged in via the adapter to your PC, start the Proteus Manager software.
3. The Proteus Manager will scan all available ports for the Proteus every 30 seconds. Once it has been detected the program will identify the port on the bottom left bar and within a few seconds the data will start scrolling.

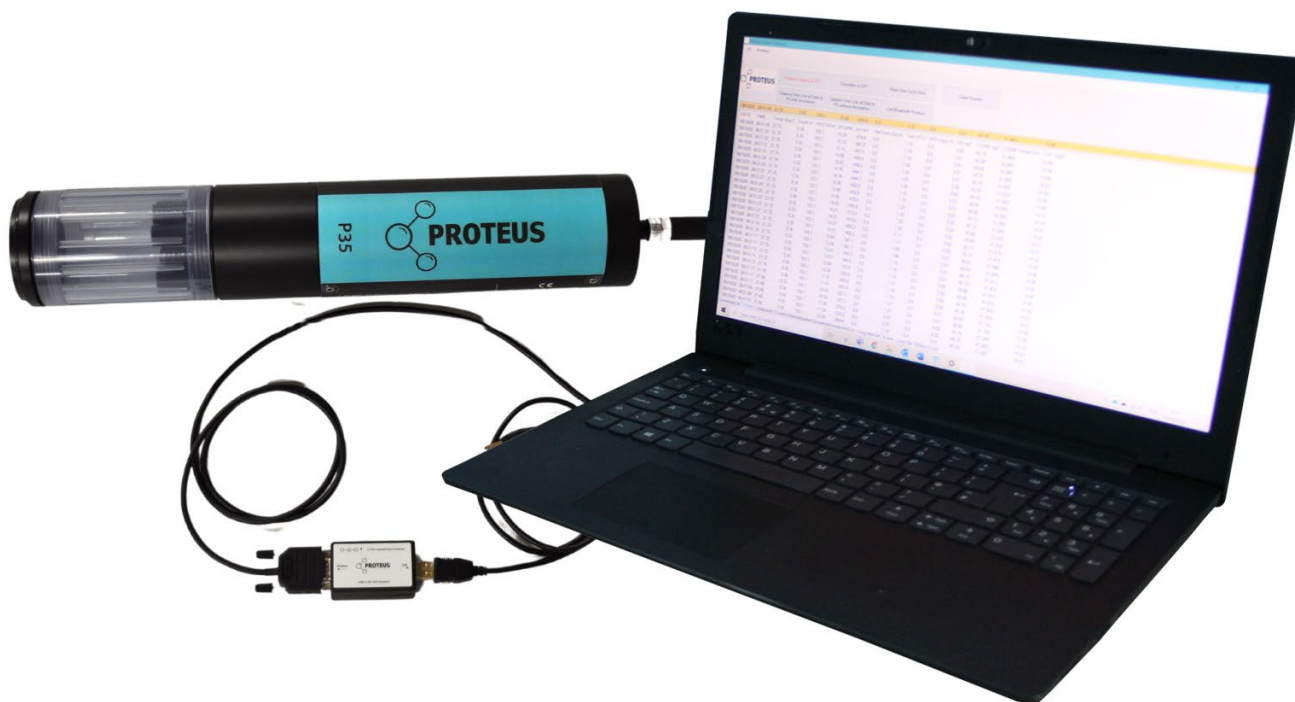

Figure 45: A Proteus connected to a PC using the supplied RS232 adapter and cable

4. Ensure Proteus Manager is set-up for logging the following parameters (these should be set-up but it is good practice to check prior to use of the instrument):
 - TRYP TempCorr*
 - CDOM TempCorr*
 - Turbidity*
 - Temperature
 - pH
 - ORP
 - Conductivity
 - Dissolved Oxygen (HDO)
 - BOD
 - COD
 - Total Coliforms
 - DOC
 - TOC

*these parameters are essential for calibration of derived parameters (BOD, COD, Total Coliforms, DOC, TOC).

Spike Concentrations:

For the test, a starting volume of 4L of clean application water is spiked up to a total of 127.75mL of contaminant solution added over 15 steps.

Table 6. Spike test volumes. Values in bold indicate the contaminant volumes at each step.

Step	Spike volume added (mL)	Total spike added (mL)	Spike %	Volume of sample removed (mL)	Volume of clean water added (mL)	New Volume (mL)	New Dilution
1	0	0.00	0.0000%	-	0	4000.00	0.0000
2	0.25	0.25	0.0047%	1000	1000	4000.25	0.0000
3	0.25	0.50	0.0098%	1000	1000	4000.50	0.0001
4	0.25	0.75	0.0136%	1000	1000	4000.50	0.0001
5	1	1.75	0.0352%	1000	1000	4001.25	0.0003
6	2	3.75	0.0763%	1000	1000	4003.00	0.0006
7	4	7.75	0.1570%	1000	1000	4006.00	0.0012
8	8	15.75	0.3170%	1000	1000	4012.00	0.0024
9	16	31.75	0.6345%	1000	1000	4024.00	0.0048
10	32	63.75	1.2629%	1000	1000	4048.00	0.0096
11	64	127.75	2.4962%	1000	1000	4096.00	0.0191
12	0	0	1.8571%	1000	1000	4064.00	0.0139
13	0	0	1.4151%	1000	1000	4000.00	0.0106
14	0	0	1.0614%	1000	1000	4000.00	0.0080
15	0	0	0.7960%	1000	1000	4000.00	0.0060

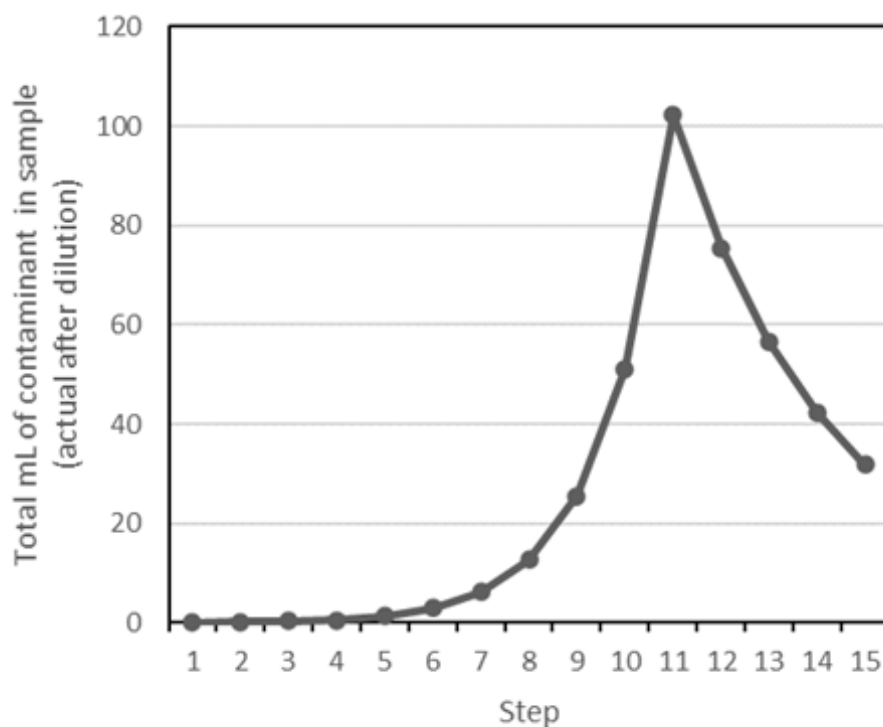

Figure 46. Example of simulated pollution event as spike contaminant concentration (mL) in 4L volume after dilution.

Protocol:

1. In advance collect the contaminant solution – bring to lab (sample should be kept refrigerated until ready to run test). Can be at ambient temperature while running test.
2. Measure 4L of clean matrix water into the beaker.
3. Set-up beaker on magnetic stir plate and set stirring rate so no particulates are settled on bottom, avoid introducing bubbles by using excessive speed.
4. Remove sensor storage cup and introduce Proteus into the sample beaker, press “Wipe One Cycle Now” to initiate cleaning mechanism to remove any bubbles which may be on the sensor windows (bubbles will affect the measurement if not removed). Ensure all sensors are fully submerged – marking depth will ensure all samples are treated similarly (Figure 47). It is Perform wipe cycle for each stage prior to making readings.
5. Observe readings until stabilised and press “Auto Snapshot” to log approx. 20 stable readings. Save log file with clear naming convention which can be linked to lab sample data e.g., Spike_0 to 15).
6. Carefully remove Proteus and rinse off with DI H₂O. Replace sensor storage cup to prevent accidental damage.
7. Remove 1L and immediately bottle up samples for laboratory analytical replicates then add 1L of clean matrix water back into the beaker. Submerge Proteus and perform Wipe cycle.
8. Add the first spike concentration of 0.25mL contaminant solution and repeat from step #3 to gradually increase the concentration of contaminant in the beaker (See Table 6).

Repeat the process for all spike concentrations

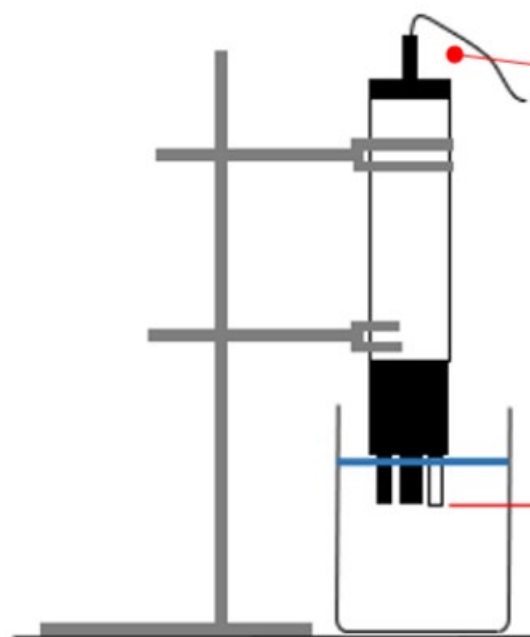

Figure 47. Example of spike test set-up in the lab. A vertical clamp is recommended for ease of measurement.

Data Format:

1. Average the values for each spike concentration.
2. Open the format-example.csv file provided by Proteus. Do not change any formatting.
3. Insert mean values for Proteus Turbidity (TURB) Tryptophan (TrypTempCorr / TRYP_T) / CDOM (CDOMTempCorr / CDOM_T), include EC if available.
4. Insert the paired mean lab sample values from the tests into columns headed with LAB_.
5. Return data to Proteus for running of calibration algorithms.

	A	B	C	D	E	F	G	H	I	J	K	L	M	N	O
1	DATE	Spike	TURB	TRYP_T	CDOM_T	EC	LAB_BOD	LAB_COD	LAB_TOC	LAB_DOC	LAB_ECOLI	LAB_TOTCOLI	LAB_FAEICAL	LAB_PHOS	LAB_ENTERO
2	#####	1	74.72	1.16	5.52	41.42	9.23	45.03	22.5	32.34	535.34	543.31	343.21	232.45	223.32
3															
4															
5															

Figure 48. Example of the format-example.csv spreadsheet. Yellow columns contain mean Proteus readings. Grey columns contain mean lab sample values.

6.11 Calibration of other Sensors

In the following section there is a description of the remaining sensors available to purchase with a Proteus and their calibration procedure. Please be aware, temperature is not listed as it does not require calibration. To access the parameters:

Proteus Drop-down Menu → Calibrate → Select parameter from list.

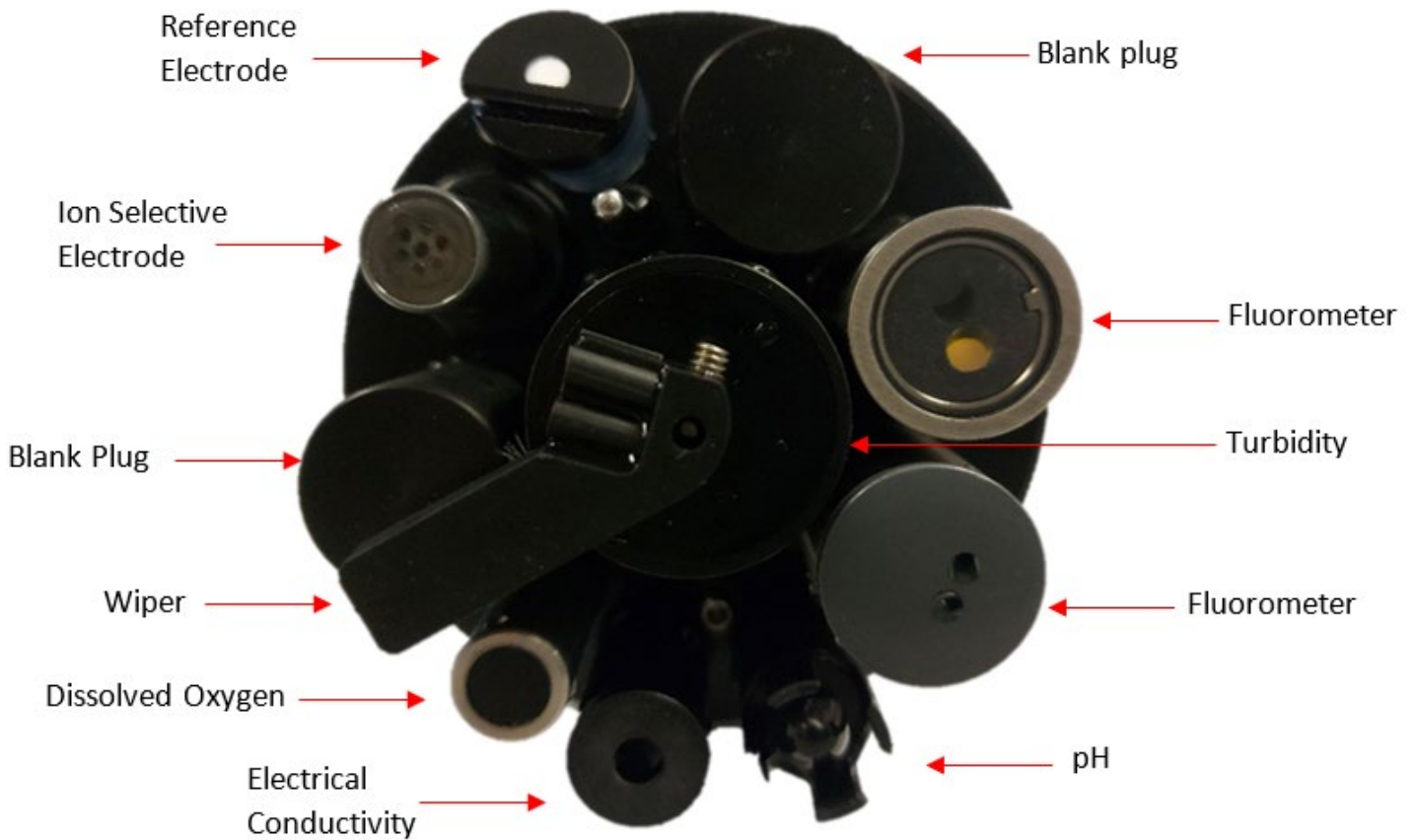
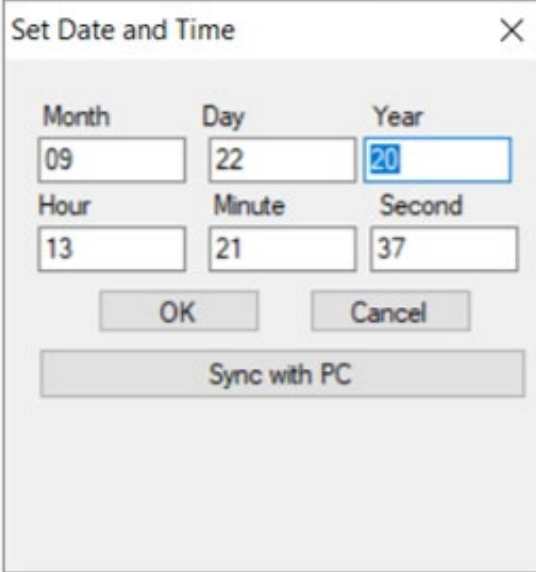

Figure 49: Proteus Sensor Identification.

6.11.1 Setting Time, Date and Barometric Pressure (BP)

The time and date are typically set to a default. You can change this to the local time-zone either manually or using the 'synch to PC option' (Figure 50). Note: The date is displayed in the American format of Month/Day/Year.



The 'Set Date and Time' dialog box features a close button (X) in the top right corner. It contains six input fields arranged in two rows. The first row has fields for 'Month' (09), 'Day' (22), and 'Year' (20). The second row has fields for 'Hour' (13), 'Minute' (21), and 'Second' (37). Below the input fields are three buttons: 'OK', 'Cancel', and 'Sync with PC'.

Figure 50: Set Date and Time command prompt.

Barometric Pressure is required if you have a Dissolved Oxygen sensor. The BP can be entered in two ways, either in mm/Hg (if known) or by entering the elevation above sea level, and the software will calculate the approximate BP based on this. Entering the mm/HG is preferred as it has a greater accuracy; the information can usually be obtained using local weather forecasts.

Note: Whichever field is filled, the other will auto-calculate based on the provided values.

If your Proteus is equipped with an un-vented depth sensor, you can also automatically set the BP by using 'Get BP' (Figure 51). To do this, simply remove the calibration cup and have the Proteus steady on a workbench or similar, ensuring the depth sensor is exposed to air. The correct values will then populate the BP and altitude fields.

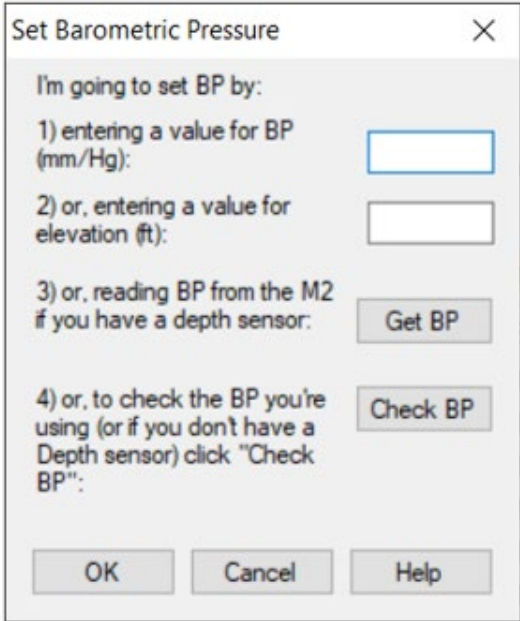

The 'Set Barometric Pressure' dialog box has a close button (X) in the top right corner. It starts with the text 'I'm going to set BP by:'. Below this are four options, each with a corresponding button or input field: 1) 'entering a value for BP (mm/Hg):' with an empty input field; 2) 'or, entering a value for elevation (ft):' with an empty input field; 3) 'or, reading BP from the M2 if you have a depth sensor:' with a 'Get BP' button; 4) 'or, to check the BP you're using (or if you don't have a Depth sensor) click "Check BP":' with a 'Check BP' button. At the bottom are three buttons: 'OK', 'Cancel', and 'Help'.

Figure 51: Set BP command prompt.

6.11.2 Dissolved Oxygen (ADO)

The optical dissolved-oxygen sensor comprises of a blue-light source, a sensing surface and a red-light receiver. The sensing surface is an oxygen-active compound stabilized in an oxygen-permeable polymer, usually silicone. When the sensing surface is exposed to water (or air), oxygen diffuses into the sensing surface according to the amount (partial pressure) of oxygen in the water. The oxygen active compound fluoresces under the blue light, emitting red light which is then detected by the receiver. In each measurement cycle, the blue light is first turned on and then turned off. The red-light receiver measures the time it takes after the blue light is turned off for the fluorescence to cease. The resultant value is proportional to dissolved oxygen.

The sensor output is corrected for the temperature and salinity of the water.

NB: Salinity correction is dependent on an Electrical Conductivity sensor also being fitted.

Optical dissolved-oxygen sensors generally have very low drift rates (compared to the electrode method), so experience will define how often your optical sensor needs calibrating.

The tip of the optical dissolved oxygen sensor (ADO) must be replaced periodically, typically once every 4 years. If your SRF reports less than 100% or if you notice that the sensor's readings are getting noisy (i.e. the data is fluctuating beyond the normal range), this is typically indicative of the tip requiring changing. The tip is simple to replace though unscrewing the old tip and replacing with the new tip. Calibration is required with each new sensor tip. Proteus is an advocate of the "air-saturated water" calibration method as opposed to the "water saturated air" calibration.

It should be noted that the sensor appears on all lists as 'ADO or HDO', the 'A or H' is in reference the original sensor manufacturer. The default DO sensor is ADO. Legacy Proteus units may be fitted with an HDO sensor.

Procedure for Air-saturated calibration of DO sensor:

1. Ensure BP has been set and is accurate.
2. Fill a 1l container with 0.5 litres of water, fix on the lid and shake vigorously for approximately 1 minute 30 seconds.
3. Expel as much air as possible by squeezing the bottle, replace the lid and repeat step 2.
4. Affix the Proteus calibration cup to the main housing and invert the probe so the sensors are facing upwards.
5. Fill the cup with the water from the container until the DO cap is submerged by ~1 cm. Leave for 4 minutes for the temperature to equalise.
6. Follow the on-screen instructions for DO calibration – remember to select % Sat from the parameter list not mg/L.

Additional Guidance

We do not recommend that a zero-point DO is calibrated however, the Proteus software does support a zero calibration. We do recommend that the sensor's zero response should be monitored infrequently using one of the following methods:

- The simplest way to check zero response is with nitrogen gas ($N_{2(g)}$). Wrap the sensor-end of your Proteus with a plastic bag and feed nitrogen gas into the bag. Ensure there is a second outlet at the opposite end of the bag for the air to escape. If you're using a high-pressure gas bottle, please use a two-stage regulator.
- Dissolve a few grams of sodium sulphite and a pinch of cobalt chloride in a half-litre of tap water. This solution can be purchased pre-made but be careful not to aerate the solution by pouring it numerous times.
- Prepare zero-oxygen water by bubbling nitrogen through water. Use bottled gas and an aquarium-type air stone. After bubbling the gas through a litre of water for 10 minutes it should produce an acceptable zero solution.

6.11.3 Electrical Conductivity/Specific Conductance

Proteus uses the four-electrode method to determine water conductivity; two pairs of graphite electrodes are situated in a stable geometry. A constant voltage is applied to one of each electrode pair and the amount of current required to maintain that voltage is measured. As the conductivity of the water increases, the current increases.

The zero point for the sensor is set electronically and can be verified by testing the sensor in air. The reading should return 0 and therefore a one-point calibration for the “slope” point is adequate.

To calibrate the ‘slope’ point:

1. Fill the calibration cup with your conductivity standard to cover the conductivity sensor. Tap gently on the cup to make sure there aren’t bubbles trapped in the conductivity sensor.
2. Follow the Control Software’s calibration instructions.

The Proteus reports Specific Conductance as standard i.e. Conductivity of water standardised to 25°C. Conductivity has other forms including Total Dissolved Solids (TDS) and Salinity.

TDS and Salinity are calculated using conductivity and therefore cannot be directly calibrated for, it needs to be done through the conductivity calibration. They can be calibrated for by adjusting the calibration point of the conductivity sensor. Enable either TDS or Salinity using the sensor and parameter list, and then calibrate conductivity as above using the appropriate TDS or Salinity Standard; accept the calibration when your chosen parameter is reading as expected.

6.11.4 pH

pH is measured as the voltage drop across the glass membrane of a pH electrode. A reference electrode is used to complete the voltage measuring circuit. The pH glass is specially formulated to absorb water so that ions (particularly H⁺ and OH⁻) in the water are attracted to the glass to offset the ionic constituency of the pH electrode’s internal electrolyte. As a result, there is a charge separation across the glass and that’s the voltage we measure. pH readings are automatically compensated for temperature.

As before, pH can be calibrated using either two or three points, with a two-point calibration including pH 7 (neutral). If your target monitoring environment has an average pH that fluctuates both above and below 7, a three-point calibration is more beneficial.

To calibrate pH, use the process outline in Section 6.1 and follow the on-screen instructions from the Proteus Manager.

6.11.5 Oxidation-Reduction Potential (ORP)

ORP is measured as the voltage drop across the platinum membrane of an ORP electrode. The actual ORP sensor is the 1 mm silver-coloured dot you can see when looking down at the pH sensor – if your Proteus has ORP. A reference electrode is used to complete the voltage-measuring circuit. Because platinum does not react with ions in the water, it won’t give or take any electrons from those ions unless they are very persuasive. The potential (voltage) created by this refusal is what you’re actually measuring as ORP.

ORP, displayed as ORP_mV in the calibration drop-down menu, uses a one-point calibration. Follow the steps outlined in Section 6.1, ensuring both the ORP sensor and reference electrode are submerged within your calibration standard.

6.11.6 Depth and Vented Depth (Gauge)

Depth is measured by a strain-gauge transducer as hydrostatic water pressure; as depth increases so does pressure. Proteus depth sensors are usually inside the instrument, with a small pressure port that can be seen on the outside of the Proteus bottom cap.

Depth calibration should be carried out 'in-air', following the on-screen instructions on the Proteus control Manager.

The Depth sensor cannot distinguish between water pressure and the air pressure exerted on the water (i.e. barometric pressure). After you have zeroed the sensor, any change in barometric pressure will be measured as a change in water pressure. Water is 10x heavier than air so any error introduced by barometric pressure changes is small.

If increased accuracy is required the Vented Depth, or Gauge sensors are available. Vented Depth uses the same transducer as the Depth, except that there's a tiny hole in the back of the transducer. A vented cable is required, one with a small hollow tube running through it. Atmospheric pressure is sensed by the transducer via the little hole down the vent tube. Changes in barometric pressure will therefore not affect the depth reading. Vented-Depth cables have a desiccant-filled housing at their surface end. The desiccant keeps water from condensing in the vent tube by letting vapor escape through a small Gortex patch. The housing should be kept clean and desiccants replaced every year or when the colour change indicates so. The vent tube should not be blocked.

6.11.7 Ion Selective Electrodes (ISEs)

ISE's are traditionally used in the laboratory at a constant, moderate temperature, with ionic strength adjusters added to each sample so that the sample and calibration solution have roughly the same ionic strength. ISE's can provide valuable information in the field, for instance in watching short-term trends, but their calibration requirements, stability and accuracy are not nearly as simple and reliable as those for DO, conductivity, turbidity, etc. For field use, Proteus makes several theoretical and empirical corrections to elicit the best possible field performance.

ISE's operate much like a pH electrode except that the pH glass is replaced by a membrane that is selective for the analyte of interest (ammonium, chloride, nitrate, sodium). The electrode's filling solution contains a salt of the analyte and the difference between that salt's concentration and the analyte concentration in your water produces a charge separation. That charge separation is measured, relative to the reference electrode, as a voltage that changes predictably with changes in the analyte concentration in the water adjacent the membrane.

When not deployed, ISE tips should be stored with a small amount of water in the calibration cup to ensure it doesn't dry out. The sensing elements (tip) for Nitrate and Ammonium ISE's have service lifetimes of ~90 days, after this the tip must be replaced. Tips are easily replaceable by simply removing the expired tip and screwing a new tip on. If your Proteus is equipped with more than one ISE, use care when replacing tips so that you don't put a tip on the wrong sensor (for example put a Nitrate on the Sodium sensor).

Each sensor body is programmed for a specific ISE; the ISE is identified by a series of rings or dots. One ring or dot means the sensor body is programmed for a Chloride ISE; two = Calcium, three = Nitrate, four = Ammonium, five = Bromide and six = Sodium.

Note that the Ammonium ISE senses ammonium, but at pH's higher than 8 the ammonium (NH_4^+) is mostly converted into ammonia gas (NH_3). Proteus's software uses the pH, Conductivity and Temperature of the sample water to calculate Ammonia (as mg/L-N). You can also display Total Ammonia; the sum of Ammonia and Ammonium.

Ammonium, Nitrate and Sodium ISE's suffer from interference in the presence of positive ions. All three are sensitive to potassium ions while Sodium can be affected by ammonium ions and Ammonium and Nitrate are sensitive to Sodium ions. The Chloride ISE is generally unaffected by the presence of other ions.

Note that the Sodium ISE has a plastic membrane with a wider pH range (pH 3 – 10) and less pH interference than the traditional sodium ISE's (which are made with glass membranes). This sensor is specified to have a 10 second response time and a range of 0.05 – 2,300 mg/L Na+.

The Sodium ISE can be immersed to 15 meters of water without damage, but there may be a pressure effect on the reading. Although testing on a limited sample size showed this error to be within our $\pm 20\%$ accuracy specification, we recommend that users check the performance of their particular sensors under actual field conditions. Note that the Sodium ISE has a slow response to changes in temperature and may take many minutes to reach a final reading when the temperature changes significantly.

Calibration of ISEs are usually 2-point, based on chosen standard. Follow the guidance in Section 6.1, with the exception of **allowing the reading a minimum of three minutes to stabilise** before accepting it. Ensure the ORP sensor and reference electrode are also submerged during calibration.

6.11.8 Total Dissolved Gas (TDG)

The TDG sensor is a pressure transducer attached to a "membrane". This membrane is a long piece of thin-wall, silicone tubing whose job is matching gas partial pressures inside the tube with those of the surrounding water. The sum of those partial pressures is measured by the transducer to give the TDG of the water.

If the membrane becomes soiled or damaged, the membrane assembly must be replaced. Simply unscrew the old membrane and screw on a new membrane. Screw it on finger-tight, plus 1/4 turn.

Silicone rubber is chosen for the membrane material because gases pass through silicone readily. This means that response time for silicone is much faster than if the membrane were, say, Teflon. However, if the membrane is soaked in water for more than a few hours, the silicone absorbs just enough water to slow the gas transfer considerably. This is not usually a problem for unattended monitoring applications (the TDG doesn't change very quickly) but can be annoying if you are doing daily spot-checks. In that case, it's best to dry out the membrane between stations by using only a few drops of water in the storage cup instead of a full cup.

6.11.9 PAR

The PAR sensor comes equipped with its own manual and cannot be calibrated by the end user. If you require additional information, please contact info@proteus-instruments.com.

7. Communication and Data Logging

When unattended data capture is required the “snapshot” function is not suitable as it requires a hard-wired connection to a laptop or desktop computer. The Proteus offers a variety of logging and telemetry options to suit a wide range of field set-ups.

7.1 Internal Data Logging

Internal data logging has to be enabled via the computer software (Section 3) and also using the ‘ON/OFF’ switch plate on the IBP. If your probe does not come with an IBP, enable logging through the software. The LED indicator lights will confirm that logging is enabled and that sufficient voltage remains in the batteries.

The Proteus automatically synchronises logging times using the nearest hour, for example if logging with an interval of 15 minutes is set at 10:05, the first reading will be taken at 10:15 and then every 15 minutes thereafter. After enabling logging, the Proteus will continue logging at the set interval until either the switch plate is turned to ‘Off’ or the external power source is removed.

NB. For more detailed information on managing data logging refer to Section 3.

7.2 Internal Battery Packs

The Proteus can be built with an Internal Battery Pack (IBP). In addition, the Proteus can be powered using a secondary DC power source such as a solar-recharged storage battery. If you have an IBP and a secondary power source attached, the Proteus will use power coming from the secondary power source as long as its voltage is sufficient. If the Proteus cannot find adequate voltage in the Marine Cable, it will use the IBP.

7.2.1 Battery Life

If the battery runs out during deployment, logging will simply cease until the batteries are recharged or replaced. As there are many combinations of sensors for a Proteus, individual battery life will vary however Table 6 has some rough guidelines. Battery length will also be affected by operating temperature; as standard, the IBP takes 6 x 1.5V C-cell batteries.

Table 7: (Next Page) Approximate battery life of different Proteus sensor configurations.

Model	Sensors	Logging Interval	Approximate Battery Life (with IBP Industrial Grade Alkaline C cells)
Proteus 3.5"	1 x Temperature 1 x Turbidity 1 x Fluorometer	15 mins	17.9 Days
		60 mins	61.8 Days
Proteus 3.5"	1 x Turbidity, 1 x Temperature, 2 x Fluorometers, 1 x pH/ORP 1 x Reference Electrode 1 x Conductivity 1 x Depth 1 x ISE	15 mins	13.7 Days
		60 mins	48.7 Days
Proteus 4.0"	1 x Temp 1 x Turbidity 3 x Fluorometers 1 x Dissolved Oxygen 1 x pH/ORP 1 x Reference Electrode 1 x Conductivity 1 x Depth 2 x ISEs	15 mins	10.0 Days
		60 mins	36.6 Days

7.2.2 Changing the IBP batteries

Before changing the IBP batteries, please do the following:

- Ensure all dirt, grit and other debris has been cleared and the probe thoroughly dried as sealing surfaces will be exposed.
- Ensure all batteries are changed at the same time and use the same brand of battery.

To change the batteries:

1. Grasp the eyebolt on top of the battery housing (Figure 50) and unscrew until the cap moves free of the housing.
2. Remove the spent batteries, paying close attention to any ensure all the batteries are in-tact on removal.
3. Clean any debris or dirt off of the exposed O-ring surfaces.
4. Add a small amount of silicone grease to the O-rings and the inside of the battery sleeve where the batteries sit.
5. Replace the batteries (6 x C cell), paying careful attention to the polarity diagram on the outside of the sleeve (Figure 52).
6. Replace the cap and screw the eyebolt to secure it.
7. If activating logging, move the switch bolt (Figure 52) into the 'ON' position (activation via the software must be done prior to this). The red light will flash 5 times to confirm logging has been successfully activated, followed by a single green flash to confirm adequate voltage is being received.

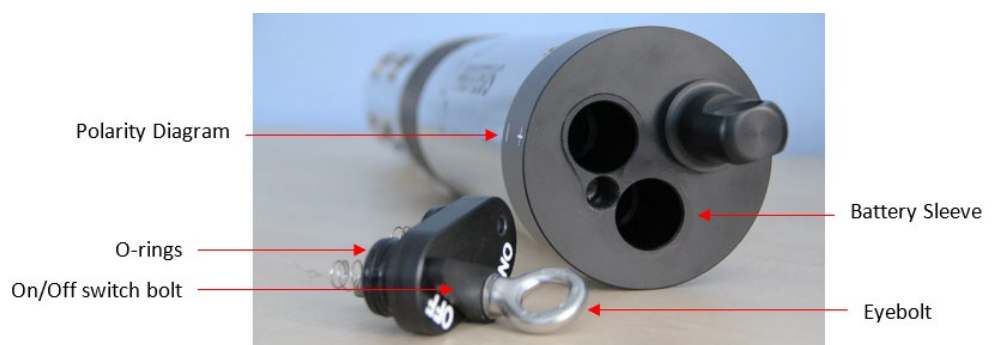

Figure 52: Changing of IBP batteries

7.3 Bluetooth

The Bluetooth Battery Pack (BBP) can be used to communicate wirelessly between the Proteus and a computer, while also supplying power to the Proteus.

The BBP contains a Bluetooth transmitter and receiver, an on/off switch and a rechargeable battery with a life of 6-8 hours. The BBP connects directly to the Proteus via a data cable and then a compatible device is connected to the module via Bluetooth.



Figure 53: Proteus connected via BBP to a Bluetooth enabled tablet.

The Bluetooth Battery's Bluetooth address is shown on a label on the battery itself.

For smartphones/tablets, the app is downloadable from the Google Play Store under 'Manta Control Software'.

7.3.1 Connecting to Compatible Tablets and Smartphones

The Proteus app is provided free of charge with all BBP purchases, and can be downloaded onto as many devices as required.

To connect to the app:

1. Switch the BBP using the on/off button and open the Proteus Bluetooth app on your device.
NB: The BBP LED will flash to indicate the BBP has been switch on, if no flashing occurs the unit needs charging.
2. Follow the usual steps you would take to pair the BBP to your device.
3. Once paired, select the correct Proteus from the app home screen, where the ID on the BBP will be visible.
4. When requested for a password, the default password set is '1234'.
5. Following password acceptance, the data will start scrolling.

8. Appendix

8.1 Additional Trouble shooting

Throughout the manual, various troubleshooting has been suggested however there is some more information below which you may find useful in the rare event of encountering difficulties.

8.1.1 Communication with Computer

If your Proteus is unable to communicate with your computer, please try the following:

- 1. Check all cable connections for loose or un-matched connections.**
If nothing seems amiss, disconnect and reconnect all cables and restart the software, to resolve the issue.
- 2. Ensure both your computer drivers and software used is up to date** – please note this can include operating system updates as, if they are overdue, can disrupt how your computer works.
- 3. Check that the COM port being used by the USB adaptor matches the COM port detected in the Proteus Control software** – this is more applicable when you have multiple units connected but select a different COM port for the Proteus if it is not being detected.
- 4. Once connected, check if the LED at the top of the Proteus housing is flashing green** (indicative of satisfactory voltage); if it is not flashing (or you get a brief red LED flash), the Proteus is not receiving enough power to operate and should be connected to an additional power supply. You can connect an auxiliary power supply into the side of the USB-RS232 adaptor.
5. If none of the above works, and you have more than one Proteus or cable, try another to see if the issue can be isolated.
6. Additional help can also be found in 'Connecting a Proteus via an RS232 adapter' supplied on a USB drive with your Proteus.

If you have checked all of the above and the problem still has not resolved, it is possible the CPU board needs to be replaced or repaired; please contact support@proteus-instruments.com.

8.1.2 Measurement Values are Unrealistic

If the measurement values being recorded by your Proteus are 'unrealistic', please try the following:

1. **Check all sensors are correctly calibrated** - You can do this by calling up the cal log (Section 3.4.2), referencing your calibration certificate and by putting the probe into known standards. Also check the SRF factor is within limits for the most recent calibration.
2. **Check all the sensors are in good working order and regular maintenance has been carried out** Maintenance guidance is presented in Section 5, and should be carried out at regular intervals to ensure the sensors stay in optimal working order. You can observe how a lack of maintenance may have affected your probe by looking at the long-term data record as it will show if any sensors have drifted from their baseline as a result of insufficient maintenance.
3. **Check units are displayed correctly** – for example are you expecting a reading in μF which is actually being reported in $^{\circ}\text{C}$?
4. **Is there any obvious damage or water leaks?** For suspected water damage, you should immediately disconnect the Proteus from its power source until a more thorough diagnosis can be reached. The submersible cables should be checked carefully for cuts, kinks or compression damage.
5. **If a reading is linked to an optical sensor (Turbidity, DO, Fluorometers, Derived Parameters), trigger a wipe cycle to clear the sensor.** If the issue persists, remove the Probe and wipe clean the optical window.

NB: It is good practice to set-up the Proteus so a wipe cycle is triggered before each reading.

If you have attempted all of the above and the issue has not been resolved, please get in touch with support@proteus-instruments.com with details of your particular issue. Please include your Proteus serial number, screenshot of your calibration log and specific details of the problem.

8.2 Frequently Asked Questions

8.2.1 Sensors

How do I work out a maintenance schedule for my sensors?

There is no definitive rule for this, it is simply guided by judgement over the deployment period. You should start by checking frequently to get an idea of how long it takes for (if) any detrimental soiling to occur and devise a plan from there. If you are practicing unattended logging with intermittent data downloads, maintenance should be scheduled with when the data is collected from the Proteus.

Why should the Electrical Conductivity sensor be first tested in air?

A well-dried Conductivity sensor should produce a zero reading in air. This lets you know that a one-point calibration is adequate.

How do I get the barometric pressure reading for the dissolved oxygen calibration? Do I need to check it to a certified barometer?

Using any of the methods outlined in Section 6.10.1.

How often should the pH electrolyte solution be changed?

Electrolyte solution generally lasts for a minimum of two months, usually longer. However, it is dependent on the environment. If you are using unattended logging or monitoring in very low conductivity environments, the solution should be changed with each recalibration. Over time you can alter this by using your data to guide you.

How often does the turbidity wiper and brush need to be changed?

The wipers are extremely hard wearing, with only the bristles and pads requiring replacement (Section 5.2). The wiper should be replaced if it has become visibly damaged or has become stiff; It should be inspected as part of your maintenance regime. We advise they are replaced every 12 months.

The brush is also hard wearing but the service life is more dependent on the environment it is deployed in. We advise changing every 6 months as standard, however you may require more frequent changing in heavy soiling environments.

Can I customize the Proteus with different configurations of sensors?

The Proteus can house up to 12 physical sensors on one probe, and these can be retrofitted so do not all need to be purchased at the time of the initial order. Some sensors such as fluorometers can be swapped out like for like, for example replacing Tryptophan with Refined Oils – this will still require recalibration and potentially changing of coefficients which we can advise you on.

NB: Adding sensors/parameters will change the order in any logging files and snapshot files, as well as the settings of the native RS232 and SDI12 outputs. If you add parameters but do not re-program the communication protocols, they will be improperly indexed and the output data will be mis-matched with the parameters. This also affects telemetry systems

What is the operational life of ISE tips?

ISE tips usually have an operational life of six months from the point of installation; however, this can be both shorter and longer. Plan to change tips every six months and monitor your data to ensure you do not need to change them more frequently.

Why is one of the optical sensors reading in the negative?

Technically negative optical readings are impossible but can occasionally appear, particularly in very low turbidity environments. If it is only slightly (<2 units) into the negative, take the reading as a 0 reading. If it is consistently reading into the negative or displaying lower negative values (>2 units), this is most likely an issue with calibration, either a poor calibration or significant drift and the sensor requires recalibration.

8.2.2 Calibration and Maintenance

How do I know when I need to calibrate my sensors?

Simply put, the more frequently you calibrate, the more accurate your data will be. The more meticulous you are with the calibration process, the more accurate your data will be. Sensors differ in their capacity to drift, so regular reviewing of your data is required in order to understand when the sensors require calibrating. In general, most Proteus sensors can go for six months before recalibrating is required, ISEs are an exception and tend to require recalibration every six weeks.

For derived parameters (BOD, COD, TOC, Coliforms etc.), additional site sampling should be undertaken to improve the accuracy of the algorithm underpinning these parameters. Site sampling should cover the entire range of expected values and therefore conditions that trigger changes in values. These can benefit from being updated on different timescales e.g. with seasonal change. For more information on site sampling, please refer to Section 6.9 or contact support@proteus-instruments.com to speak with a member of staff.

How do I choose calibration standards?

You should select standards based on the range of values you would expect to see in the field. Some parameters have defined standards, for example Electrical Conductivity (Section 6.2) whereas others it can be based either off previous observations or generic ranges. If you are intending to move your Proteus through different environments, you should re-calibrate between each one where necessary.

Always source your standards from a reputable supplier who has relevant MSDS documentation and standards are verified. Please contact support@proteus-instruments.com if you require any additional help sourcing calibration standards.

What is an SRF?

The SRF is a numerical value that is provided by the instrument to indicate how well the sensor is responding (Section 6.4).

For example, if a Conductivity sensor should report 100 μA in a 1413 $\mu\text{S}/\text{cm}$ standard and your particular Conductivity sensor also reports 100 μA in that same calibration solution, then your SRF is 100%. If your response is 80 μA , your SRF would be 80%. When you click the OK button to accept a calibration, the Proteus automatically accepts your calibration if the SRF is between 60% and 140%. If the SRF falls outside that range, you will be cautioned to check your standard value, make sure the sensor is clean, make sure the reading has stabilised, etc. But you can elect to accept any SRF.

Some parameters, such as pH, have a more complex SRF calculation, and wouldn't be based on 100 but the effect is the same.

Can I use a Calibration solution more than once?

We do not advise that you re-use solutions as this risks cross-contamination.

What is the difference between calibrating Dissolved Oxygen to % Saturation and mg/L?

Percent saturation tells you how much oxygen you have compared to how much you would have if the water were saturated with oxygen. Milligrams per litre tells you how many milligrams of oxygen are dissolved in one litre of water.

For instance, if your Proteus was reading 6.0 mg/L and the saturation tables told you that at that temperature, salinity and barometric pressure the saturation value was 8.0 mg/L, then your % sat would be $6/8 = 75\%$. You can use either measurement, or both, but % sat is helpful during DO calibration because it should always be 100%.

8.2.2 Calibration and Maintenance (continued)

What is the difference between the AMCO Clear Turbidity standard and Stablcal?

AMCO Clear is made of polymer beads while StablCal is a Formazin compound. Most people require their turbidity measurements referenced to the Formazin standard and so use Formazin or StablCal for calibration purposes. The polymer beads are lower cost and more stable, but you must know the equivalent Formazin value for any polymer bead standard. You cannot rely on what's written on the polymer-bead label; you must check it with your own instrument after it has been calibrated with Formazin or StablCal.

What can I use to clean my Proteus?

Sensors are best cleaned with warm water and 0.05M acid – they cannot be cleaned with abrasives, strong acids/bases or other harsh chemicals. For more information, refer to section 5.1 of this manual.

8.2.3 Communication and Software

What is the range of Bluetooth?

Typically, 10m but this varies depending upon the device.

How long does the BBP take to charge?

We recommend charging the BBP overnight, but partial charges can be obtained within 1-2 hours.

What is the top yellow line of data scroll on the Control Software?

The data displayed in the top, yellow highlighted line on the control software is your most recent line of data collected.

I've added a new sensor/parameter to the software display but it isn't showing on the data scroll?

The software can display up to 17 columns (15 columns after Date and Time), if you have selected more outputs than this, the software cannot display them. Your display may have columns which you do not require to be recorded, such as battery voltage, and removing these from the display can make room for other sensors/parameters.

I've selected a new sensor from the "Sensor and Parameter List" but there are no values/the same repeated value in the data scroll?

All possible Proteus sensors are contained in the "Sensor and Parameter list" however, you will only be able to display the ones you have the physical sensors or algorithms programmed for. If you want to add additional sensors or parameters to your Proteus, contact support@proteus-instruments.com.

8.2.4 Deployment and Actions

How long will the batteries last?

This varies depending upon the type of battery used as well as the sensor configuration of your instrument. Some rough guides are given in Section 7.2.1.

At what Voltage will the Proteus cease logging?

There isn't a hard threshold however when voltage drops below 5 VDC, it may no longer be sufficient to power the Proteus properly. Proteus units generally require additional power when they contain more than three fluorimeters or will be using a cable that exceeds 15m.

Can I hang the Proteus by the cable?

Yes, when properly attached the cable can support 20kg without using an additional bail kit. However, if you are hanging for any length of time, we suggest using a bail kit regardless to help prevent any equipment damage. If the load is going to exceed 20kgs, you will require a bail kit.

Where can I deploy my Proteus?

The Proteus can be deployed in a range of environments using different methods outlined in Section 4.0. In general, avoid positions which are at high risk of silting or are disturbed by aeration, as this can interfere with Proteus readings. Ensure there is nothing obstructing the face of the sensors and that it is in a representative position for the goal of the data collected e.g. if the goal is to measure flowing water, having the Proteus up against a bank where there is less water movement will not give representative results compared to being out in the main flow area.

To help with deployment in more challenging environments, we offer a range of anti-foul guards, flow cells and can advise on stilling wells etc., to ensure you get the best set-up possible.



8.3 Six Ways to Power a Proteus in the Lab or Field

Proteus Instruments offers several different ways to power your Proteus; choose the one (or more) that best fits your operation. Note that most of the power options can be used with a Proteus Underwater Cable or Data Cable. In situations where the top of the Proteus will be exposed to water you should always use the Proteus Underwater Cable. For your convenience, the Proteus has a green LED whose blinking tells you that the Proteus is receiving adequate operating power. With any of the power options explained below, the absence of the blinking, green LED means that your power supply is not adequate to operate the Proteus. Check your cable connections, charge or change your batteries, to fix the problem.

8.3.1 Using Power from a Bluetooth Battery Pack (ordered separately)

The Bluetooth Battery connects your Proteus to various Android and Apple smart phones and tablets. Not only does this save you the cost of expensive, fixed-purpose data displays, but it frees up one hand since you don't have to hold onto the Proteus cable. To connect this way:

- Attach one end of your Cable to your Proteus and the other end to the Bluetooth Battery.
- Turn on the Bluetooth Battery with the On/Off switch; you'll see a blue ring around the button that blinks until the Bluetooth Battery pairs with your Bluetooth device.
- Turn your Bluetooth device on, and make sure Bluetooth is activated (see your display device's manual).
- Launch the MantaLink app on your display device; that makes your device look for the Bluetooth Battery.
- Once the Bluetooth Battery and your Bluetooth device have found each other ("paired"), the blue ring will turn solid and you'll see scrolling data.

MantaLink Software Download	
Android	
iOS	



For more information on using the Bluetooth Battery Pack, please consult the "Bluetooth Battery Manual".

Please note: If you are using a previous version of the Bluetooth Battery Pack, you will need to download the legacy version of the software.

MantaLink Legacy Software Download	
Android	



8.3.2 Internal Battery Pack

Most Proteus models can be ordered with an Internal Battery Pack that accommodates six C-cell batteries. The Internal Battery Pack is a handy way to power Proteus' in long-term logging deployments.



8.3.3 Using Power from a PC USB Port

You can power your Proteus from the USB port on your PC or laptop connection to your Data Display. This is especially helpful in the lab during calibration, etc. To connect this way:

- a. Load the Proteus Control Software and the device driver for the USB Adapter onto your PC per the instruction manual or Quick-Start Guide included with your Proteus.
- b. Connect your Cable to your Proteus, the other end of the Cable to the USB Adapter, and the USB Adapter to a USB port on your PC.
- c. Launch your Proteus Control Software as usual.

Power to the Proteus can be boosted in this configuration by plugging a 12-volt adapter in to the RS232 USB adapter in to the port on the side. See section 8.3.4 for guidance.

8.3.4 Using Power from the USB Adapter Power Connection

If your Proteus has a large number of sensors, or if your Cable is too long, your PC's USB port may not be able to supply enough power to your Proteus. This is easily remedied with a power supply connected to Proteus's USB Adapter. To connect this way:

- a. Attach one end of your Cable to your Proteus and the other end to the USB Adapter.
- b. Connect the USB Adapter to a USB port on your PC.
- c. Connect a 12v power source.
- d. Launch your Proteus Control Software as usual.



If you experience connection issues with this method, please consult the "Connecting a Proteus via an RS232 Adapter" guide for assistance.



Note: Do not connect your USB Adapter to any power source greater than 15 VDC, doing so could seriously damage your Proteus and invalidate any existing warranty.

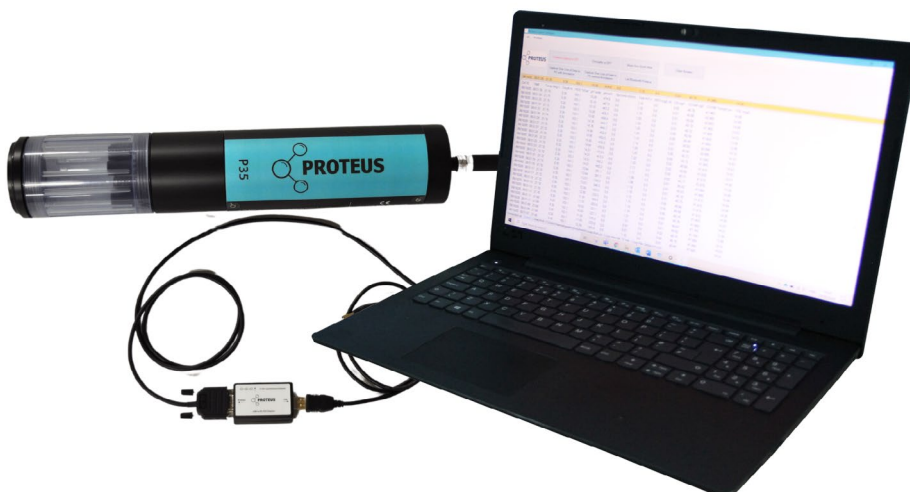

8.3.5 Using Power from Your Own Battery or Other Power Source

In some instances, you may wish to power the Proteus with an alternate source of power - for instance with a solar-backed battery in telemetry applications – with the Optional Battery Cable. To connect this way:

- a. Attach a Cable to your Proteus.
- b. Attach the other end of the Cable to the Optional Battery Cable – it can only fit one way.
- c. Connect the leads from the Optional Battery Connector to your battery or other power source providing between 9 and 15 VDC, using the red wire for positive and the black wire for ground.
- d. If you are using a PC or laptop for your display device, connect the remaining connector on the Optional Battery Cable to Proteus' USB Adapter Cable and then to a USB port on your PC.
- e. Launch your Proteus Control Software as usual.



Note: Do not connect your Optional Battery Cable to any power source that is connected to a high-voltage power source (such as a 240v power plug on the wall). Safety is of paramount importance, high voltages and water are a dangerous combination.

8.3.6 Directly from a Proteus Telemetry unit

The Proteus telemetry option can power your Proteus directly using the marine cable. The Telemetry unit can be connected to the mains, powered by solar panel, or linked to a battery pack (with appropriate conversion to act as a mains supply). In all cases the Telemetry unit powers the Proteus whilst being recharged externally itself. To connect this way:

- a. Be sure to follow all steps in the Telemetry guidance carefully.
- b. Connect the marine cable to the Proteus BD Telemetry unit.
- c. Connect the marine cable to the Proteus.
- d. Follow the Telemetry guidance for activating the unit.



9. Glossary and Abbreviations

BP	Barometric Pressure
BBP	Bluetooth Battery Pack
BOD	Biochemical Oxygen Demand
BOD5	Biochemical Oxygen Demand measured using the 5-day incubation method where a sample is incubated for 5 days at 20 degrees to determine oxygen consumption.
Calibration Cup	The screw on, plastic cup that comes with every new Proteus multiprobe. The cup screws onto the end of the Proteus and has a black rubber stopper on the opposite end which can be removed to add calibration fluids.
COD	Chemical Oxygen Demand
Derived Parameters	Refers to any/all of the parameters which are calculated using one or more fluorometers e.g. BOD, COD, TOC, DOC, Coliform types.
EBP	External Battery Pack (no longer available)
IBP	Internal Battery Pack
Tryptophan-like Fluorescence	Often abbreviated to TLF, Tryptophan-like fluorescence is the fluorescence primarily identified through the amino acid 'Tryptophan' and other organic matter that excites and emits on the same wavelengths. It can be used as a proxy for microbial activity.
Humic-like fluorescence	Often abbreviated to HLF, Humic-like fluorescence is the fluorescence primarily identified as a result of humic substances such as soil, peat and coal as well as other organic matter that excites and emits on the same wavelengths. It can be used as an indication of organic carbon loadings.
PCI	Proteus Control Interface – the software used to upload coefficients for derived parameters to the Proteus multiprobe (those models manufactured after September 2020)
Proteus Manager	Standard computer software used to calibrate, set logging and receive data when the Proteus is connected to a laptop/PC.

